

## INSTALLATION INSTRUCTIONS

**69-8611TS**  
**TOYOTA**  
**2007-11 Camry**  
**2009-15 Venza**  
**V6-3.5L**

**TOOLS:**

Flat Blade Screwdriver,  
 Phillips Screwdriver,  
 Ratchet, Extension, 10mm  
 Socket, Pliers, 10mm  
 Wrench, 8mm wrench,  
 3mm Allen Wrench.

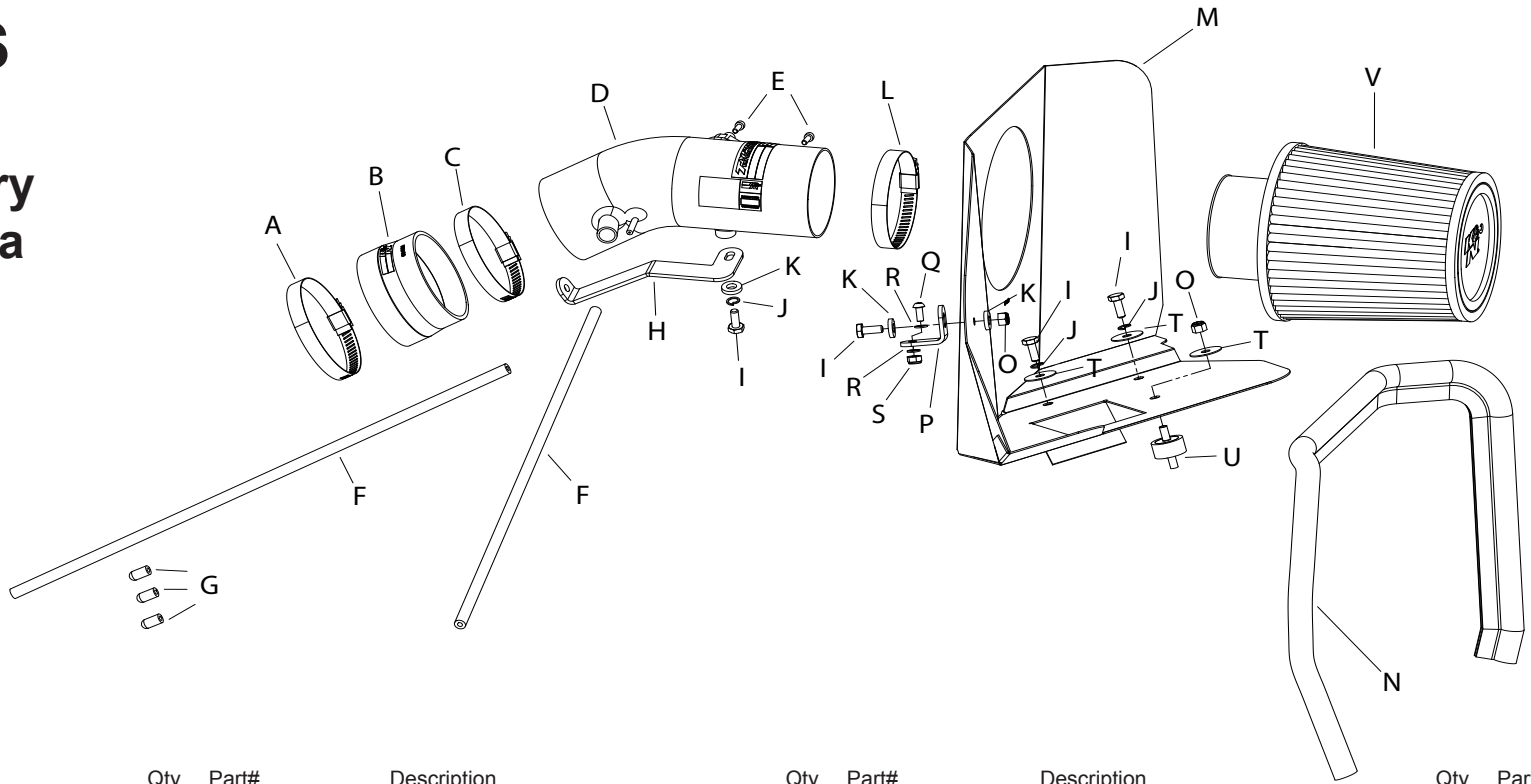

**PARTS LIST:**

Description	Qty.	Part#	Description	Qty.	Part#	Description	Qty.	Part#
A Hose Clamp #48	1	08601	I Bolt; 6MM-1.00 X 16MM, SS	4	07812	Q Bolt; M5 - 0.8 X 12MM B/H, SS	1	07734
B Hose; 3"ID - 3-1/8"ID X 2"L, TPRD; SILC, BLK	1	084031	J Washer; 1/4" Lock, ZN	3	08198	R Washer; 5MM Flat, SS	2	08212
C Hose Clamp #44	1	08577	K Washer; 1/4"ID X 5/8"OD - SAE	3	08275	S Nut; M5 - 0.8, Nylock, SS	1	07507
D Intake Tube	1	27528	L Hose Clamp #52	1	08610	T Washer; 1"D X 1/4 Hole Fender	3	08160
E Bolt; M4 - 0.07 8MM, A/H Cap, SS	2	07733	M Heat Shield	1	07650	U Stud; M6-1.00 M/M, Rubber MNTD	1	07027
F Hose; 18" 4MM	2	08153	N Edge Trim	1	102471	V Air Filter	1	RU-4990
G Cap; Rubber 5/16"OD X 5/32"ID X 11/16"H	3	08282	O Nut; 6MM Nylock, Hexhead	2	07553			
H Bracket; "L", 69-8611, STL, FB/PC	1	06485	P Bracket; "L", FIN.	1	070066			

**NOTE: FAILURE TO FOLLOW INSTALLATION INSTRUCTIONS AND NOT USING THE PROVIDED HARDWARE MAY DAMAGE THE INTAKE TUBE, THROTTLE BODY AND ENGINE.**

**TO START:**

1. Turn the ignition OFF and disconnect the vehicle's negative battery cable.  
**NOTE: Disconnecting the negative battery cable erases pre-programmed electronic memories. Write down all memory settings before disconnecting the negative battery cable. Some radios will require an anti-theft code to be entered after the battery is reconnected. The anti-theft code is typically supplied with your owner's manual. In the event your vehicles' anti-theft code cannot be recovered, contact an authorized dealership to obtain your vehicles anti-theft code.**

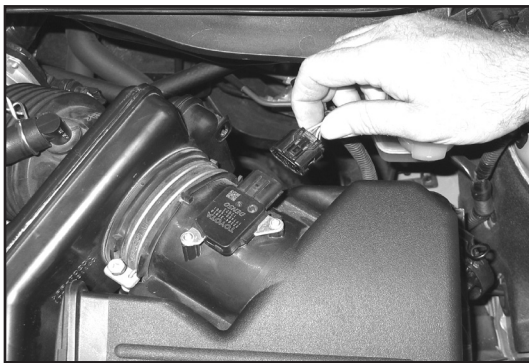

2. Disconnect the mass sensor electrical connection by depressing the center tab and gently pulling the harness away from the mass air sensor. Release the two wiring harness clips from the air box lid.



3. Gently pull the engine cover upward to release it from the mounting grommets. Once released, Remove engine cover from the vehicle and set aside.

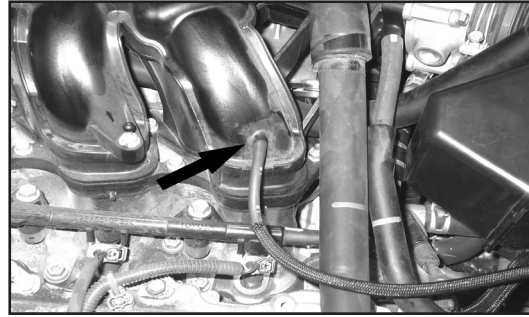

4. Disconnect the vacuum line from the intake manifold plenum connection.

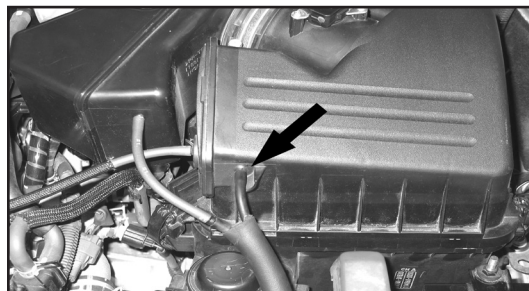

5. Disconnect the vacuum line from the upper air box lid.

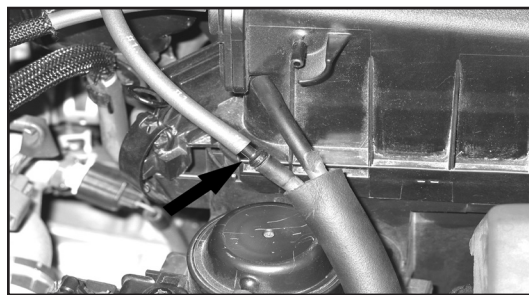

6. Disconnect the intake tube plenum vacuum line.

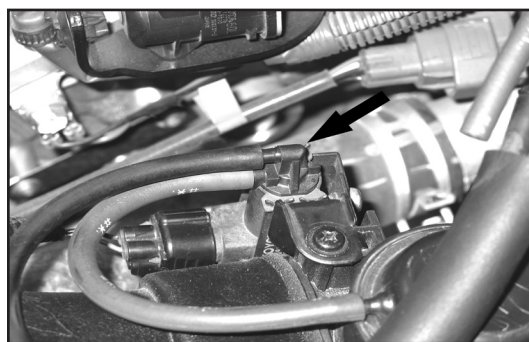

7. Disconnect the two vacuum lines from the "Vacuum switching valve."

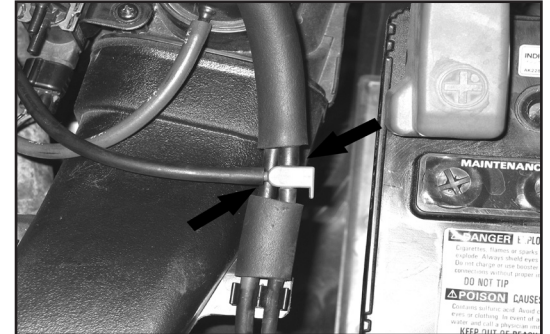

8. Disconnect the two vacuum lines from the factory "T" fitting.  
**Note: These hoses will not be re-used.**

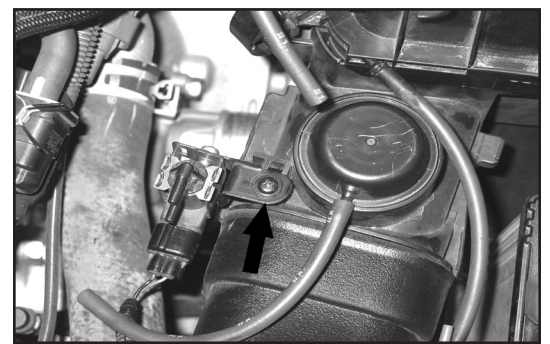

9. Remove the screw securing the "Vacuum switching valve" to the stock fresh air duct. Place the "Vacuum switching valve" in a position that will allow ample clearance to work around.



10. Release the clamp that secures the crank case vent hose to the stock intake tube and remove the crank case vent hose as shown. Loosen the clamp that secures the stock intake tube to the throttle body.



11. Release the clamps that secure the upper air box. Remove the upper air box and intake tube assembly.

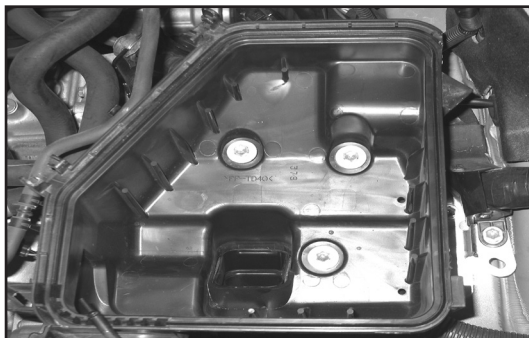

12. Remove the air filter. Remove the three bolts that secure the lower air box to the mounting bracket.



13. Remove the lower air box from the vehicle.  
**NOTE: K&N Engineering, Inc., recommends that you do not discard your factory air intake.**

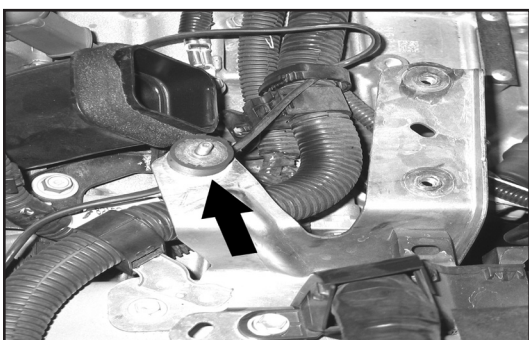

14. Install the rubber mounted stud onto the air box mounting bracket in the forward mounting hole location as shown in the photograph.



15. Install the edge trim onto the heat shield.  
**Note: Some trimming of the edge trim may be necessary.**



16. Install the "L" bracket (070066) onto the heat shield.  
**Note: The slotted end of the bracket is to be attached to the heat shield.**

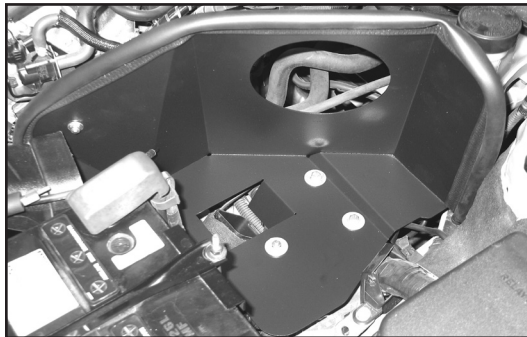

17. Place the heat shield into position, aligning the front mounting hole with the rubber mounted stud installed in step #14. Secure the heat shield to the air box mounting bracket using the hardware provided.

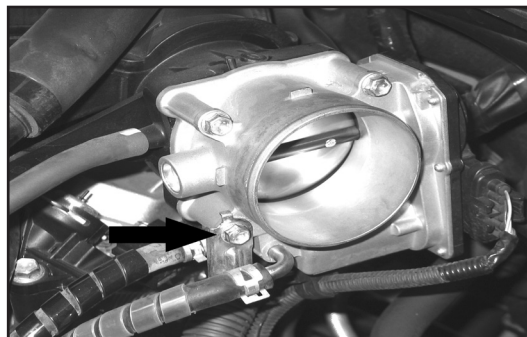

18. Remove the front lower throttle body mounting bolt.

**Note: Bolt will be re-used; do not discard.**



19. Install the intake tube mounting bracket (06485) onto the throttle body and secure with the bolt removed in the previous step.



20. Install the provided silicone hose (084031) onto the throttle body and secure with the provided hose clamp.

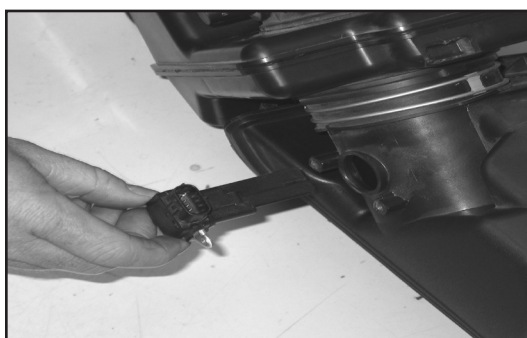

21. Remove the two screws that secure the mass air sensor to the stock intake tube. Remove the mass air sensor as shown in the photograph.

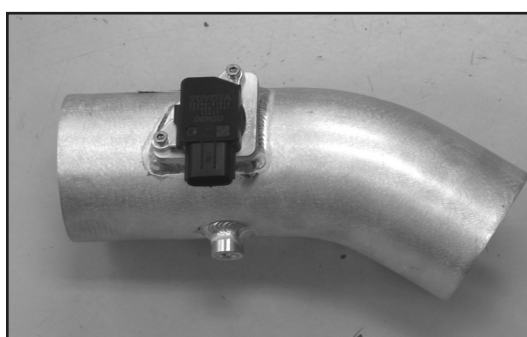

22. Install the mass air sensor removed in the previous step into the K&N intake tube and secure with the provided hardware.



23. Install the K&N intake tube into the silicone hose installed onto the throttle body in step #20. Align the K&N intake tube with the intake tube mounting bracket installed in step #19. Secure silicone hose with provided hose clamp and mounting bracket with provided hardware.

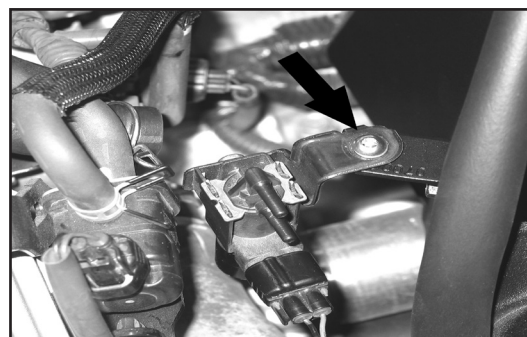

24. Secure the "vacuum switching valve" to the bracket installed onto the heat shield installed in step #16.

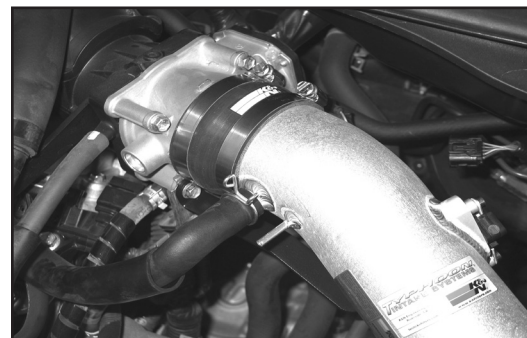

25. Connect the crank case vent hose to the fitting on the K&N intake tube; secure with the factory spring clamp.

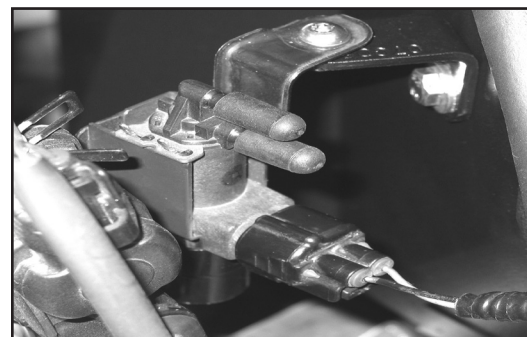

26. Install the two vacuum cap plugs onto the "vacuum switching valve."

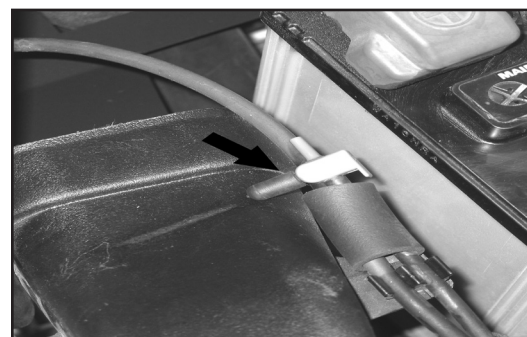

27. Install one vacuum cap plug onto the the factory "T" fitting as shown in the photograph.

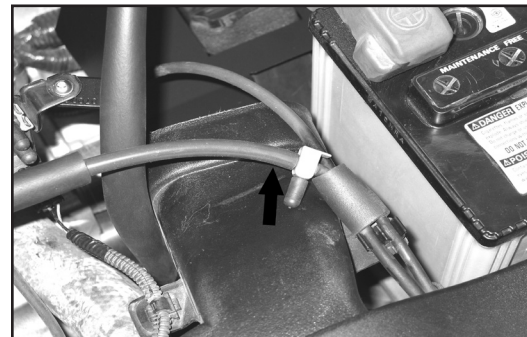

28. Install the supplied vacuum hose onto the factory "T" fitting as shown in the photograph.  
**Note: Supplied vacuum hose referred to will be the longer of the two provided.**

## Continued INSTALLATION INSTRUCTIONS

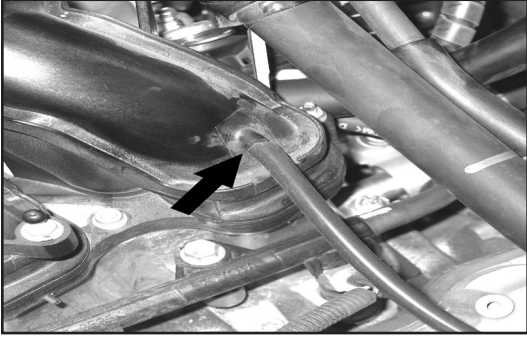

29. Connect the open end of the vacuum line installed in the previous step to the intake manifold plenum connection.

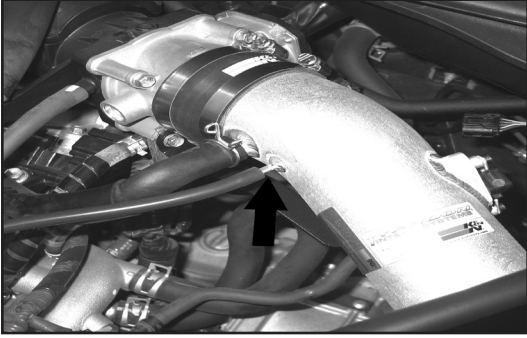

30. Install the supplied vacuum hose to the K&N® Intake Tube.

**Note: Supplied vacuum hose referred to will be the shorter of the two provided.**



31. Connect the open end of the vacuum line installed in the previous step to the stock fitting as shown in the photograph.

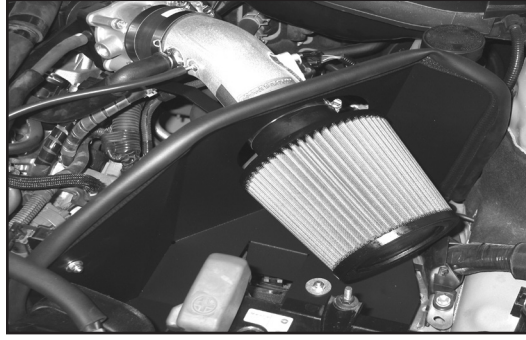

32. Install the K&N® air filter onto the K&N® intake tube; secure with the provided hose clamp.  
**NOTE: Drycharger® air filter wrap; part # RX-4990DK is available to purchase separately. To learn more about Drycharger® filter wraps or look up color availability please visit <http://www.knfilters.com>®.**

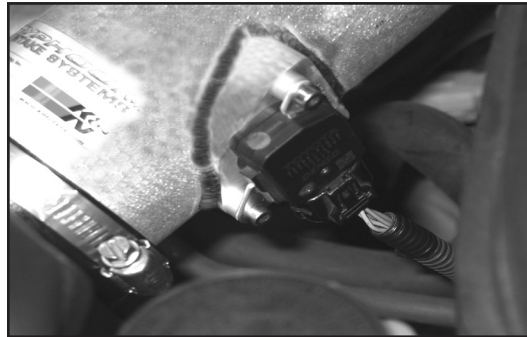

33. Re-connect the mass air sensor electrical connection.



34. Re-install the engine cover.

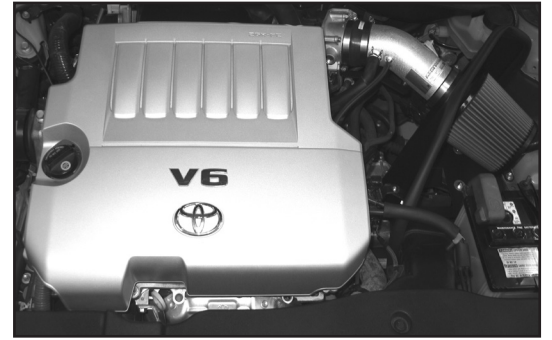

35. Reconnect the vehicle's negative battery cable. Check to ensure all hose clamps and fittings are properly tightened and positioned correctly before starting the vehicle.

36. It will be necessary for all K&N® high flow intake systems to be checked periodically for realignment, clearance and tightening of all connections. Failure to follow the above instructions or proper maintenance may void warranty.

### ROAD TESTING:

1. Start the engine with the transmission in neutral or park, and the parking brake engaged. Listen for air leaks or odd noises. For air leaks secure hoses and connections. For odd noises, find cause and repair before proceeding. This kit will function identically to the factory system except for being louder and much more responsive.

2. Test drive the vehicle. Listen for odd noises or rattles and fix as necessary.

3. If road test is fine, you can now enjoy the added power and performance from your kit.

4. K&N Engineering, Inc., suggests checking the air filter element periodically for excessive dirt build-up. When the element becomes covered in dirt (or once a year), service it according to the instructions on the Recharger® service kit, part number 99-5000 or 99-5050.

**LEGAL IN CALIFORNIA ONLY FOR RACING VEHICLES WHICH MAY NEVER BE USED, REGISTERED OR LICENSED FOR USE UPON A HIGHWAY.**

See [knfilters.com](http://knfilters.com) for CARB status on each part for a specific vehicle

\*Free K&N® decal To register your warranty, please see us online at [KNFilters.com/register](http://KNFilters.com/register). Free K&N® decal\*