



TYPHOON INTAKE SYSTEMS

INTAKE SYSTEMS FOR VEHICLES LISTED ARE 50 STATE LEGAL. SEE KNFILTERS.COM FOR CARB STATUS ON EACH PART FOR A SPECIFIC VEHICLE.

INSTALLATION INSTRUCTIONS

69-8002TS SUBARU 2004-06 Forester XT H4-2.5L Turbo

TOOLS NEEDED:

- Flat Blade Screwdriver
- Phillips Screwdriver
- Pliers
- Ratchet
- 8" Extension
- 10mm Socket
- 12mm Socket

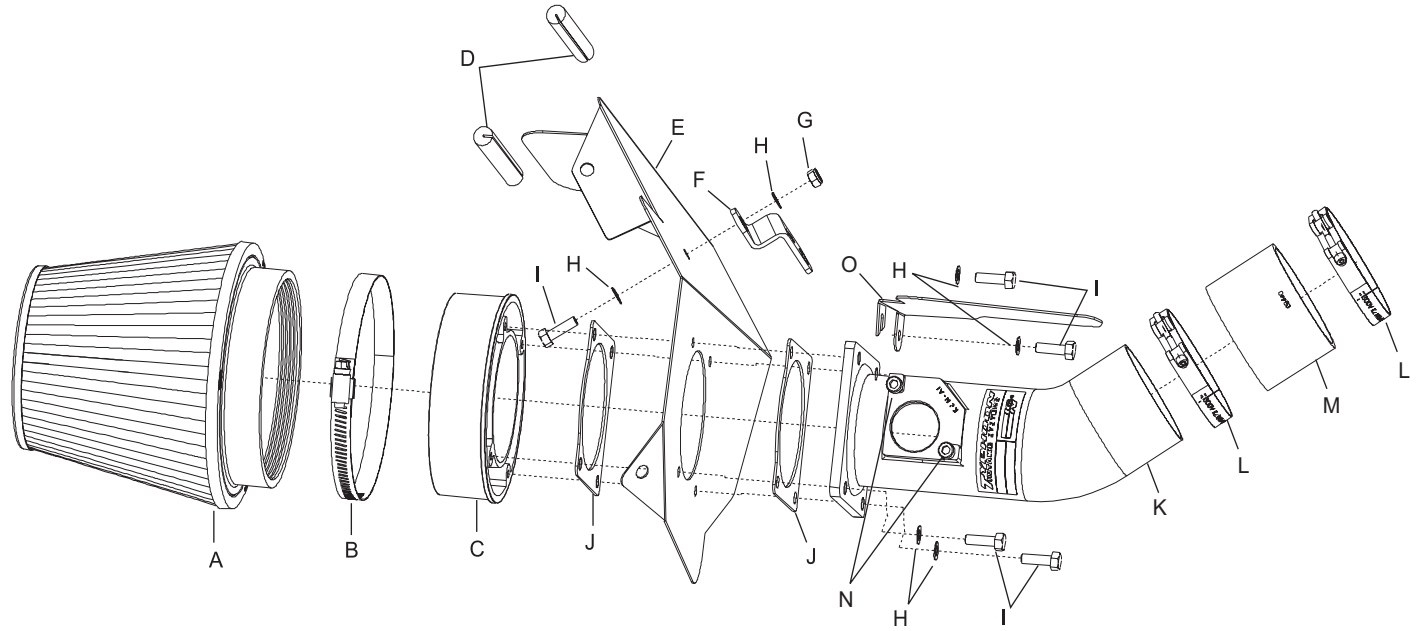

PARTS LIST

Description	Qty.	Part #
A Air Filter	1	RP-5113
B Hose Clamp #80	1	08694
C Adaptor; #350	1	21510
D Edge Trim; 1/16" Gap, 7"L	1	102452
E Heat Shield	1	07331
F Bracket; "Z"	1	010071
G Nut; 6mm Nylock	1	07512
H Washer; 6mm Wave	6	08277
I Bolt; M6 X 20mm, Hex, SS	5	07795
J Gasket; 1/16"	2	09202
K Intake Tube	1	27171
L Hose Clamp; #44	2	08560
M Hose; 2-3/4"ID X 2"L	1	08440
N Bolt; M4 X 8mm, C/H/A	2	07733
O Heat Deflector Plate	1	03467

NOTE: FAILURE TO FOLLOW INSTALLATION INSTRUCTIONS AND NOT USING THE PROVIDED HARDWARE MAY DAMAGE THE INTAKE TUBE, THROTTLE BODY AND ENGINE.

TO START:

1. Turn off the ignition and disconnect the negative battery cable.
NOTE: Disconnecting the negative battery cable erases pre-programmed electronic memories. Write down all memory settings before disconnecting the negative battery cable. Some radios will require an anti-theft code to be entered after the battery is reconnected. The anti-theft code is typically supplied with your owner's manual. In the event your vehicles' anti-theft code cannot be recovered, contact an authorized dealership to obtain your vehicles anti-theft code.



2. Disconnect the mass air sensor electrical connection as shown.

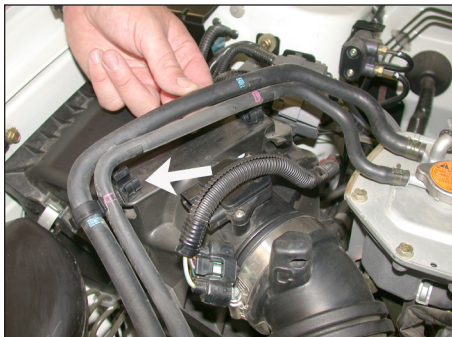

3. Unclip the coolant lines from the top of the air cleaner as shown.



4. Loosen and remove the two bolts on the air cleaner as shown.



5. Loosen the hose clamp on the turbo charger inlet tube as shown.



6. Remove the complete air cleaner assembly as shown.
NOTE: K&N Engineering, Inc., recommends that customers do not discard factory air intake.



7. Remove the mass air sensor from the air cleaner as shown.

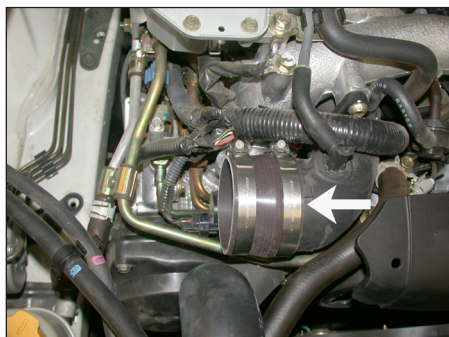

8. Install the silicone hose and hose clamps onto the turbo charger inlet tube as shown.



9. Install one of the provided gaskets onto the back of the heat shield as shown.



10. Assemble the tube, heat shield, filter adaptor, and the remaining gasket using two of the provided hex bolts as shown above.
NOTE: Before the assembly process, inspect the inside of the tube for any debris, then clean the inside out with water and a towel. Inspect the tube one more time before proceeding to the next step.

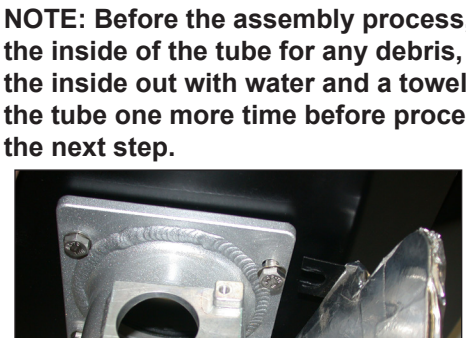

11. Using the remaining hex bolts install the heat deflector plate onto the intake tube flange as shown.

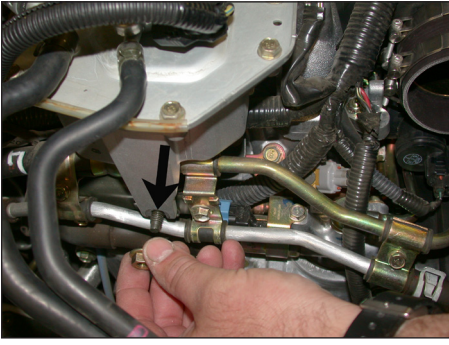

12. Remove the stock nut from the coolant reservoir as shown.

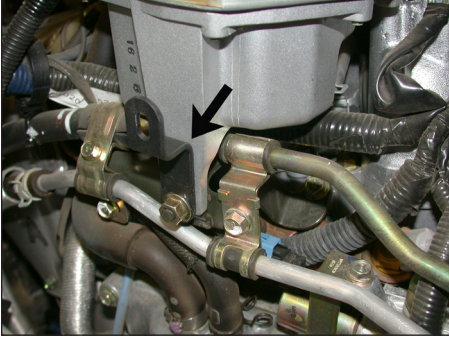

13. Install the provided "Z" bracket onto the coolant reservoir using the original nut removed in step 14.

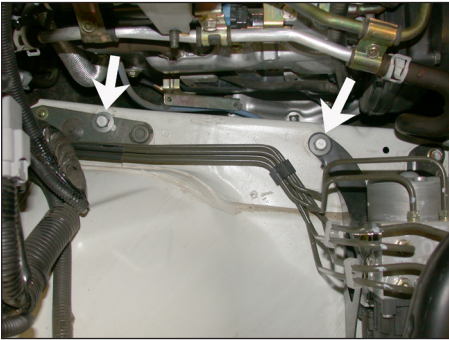

14. Reinstall the original air cleaner mounting bolts as shown above.

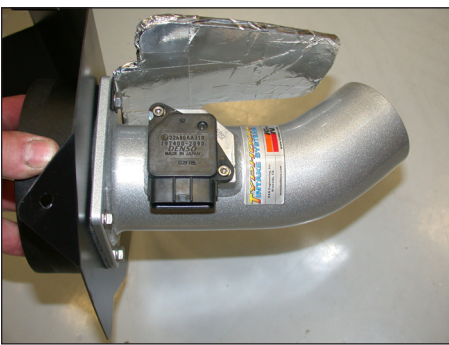

15. Install the mass air sensor into the K&N® intake tube using the provided screws as shown above.



16. Install the complete air cleaner assembly into the vehicle and slide the intake tube into the silicone hose as shown above.

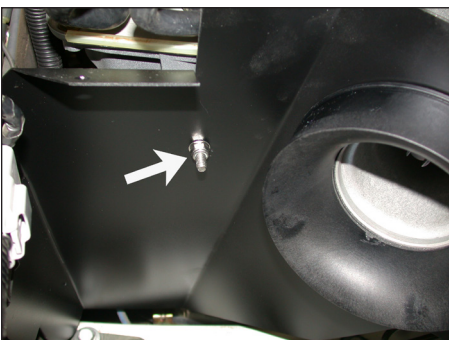

17. Secure the heat shield to the "Z" bracket using the provided hardware as shown.

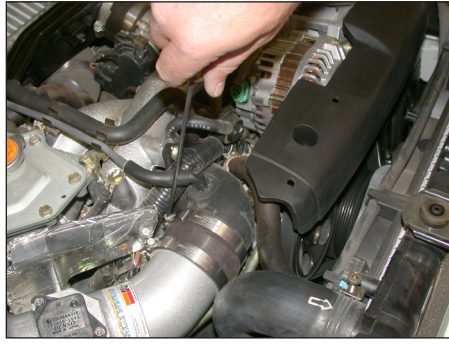

18. Tighten the hose clamp on the K&N® intake tube as shown.

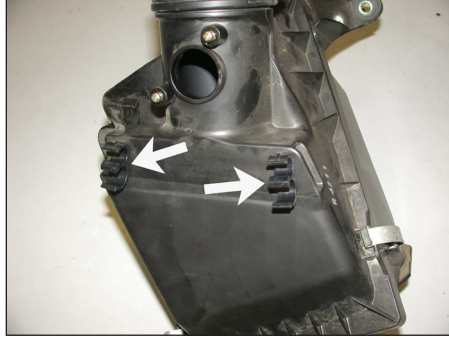

19. Remove the stock coolant clips from the stock air cleaner assembly as shown.



20. Install the stock coolant clips onto the two tabs on the heat shield, then clip the coolant lines onto the clips as shown.

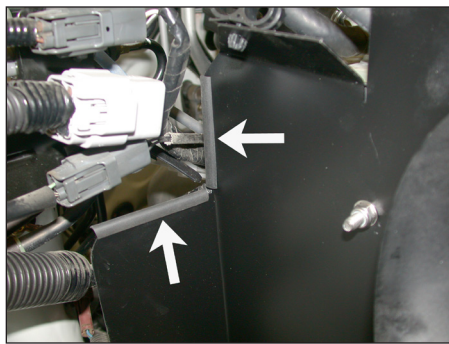

21. Cut the provided edge trim to size and place onto the heat shield as shown.



22. Unclip the wire harness from the inner fender bracket as some slack will be needed to reroute the mass air sensor electrical connection.

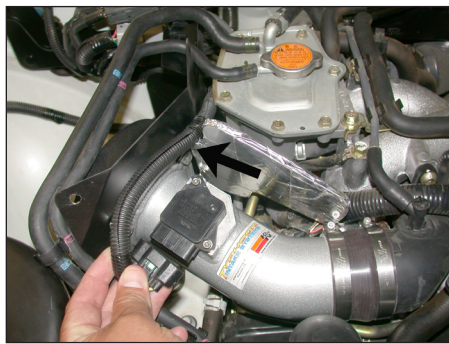

23. Reroute the mass air sensor electrical connection behind the heat shield and between the heat deflector plate and reconnect as shown.



24. Install the K&N® air filter and secure using the provided hose clamp as shown.



25. Reconnect the vehicle's negative battery cable. Double check to make sure everything is tight and properly positioned before starting the vehicle.

26. The C.A.R.B. exemption sticker, (attached), must be visible under the hood, so the emissions inspector can see it when the vehicle is required to be tested for emissions. California requires testing every two years, other states may vary.

27. It will be necessary for all K&N® high flow intake systems to be checked periodically for realignment, clearance and tightening of all connections. Failure to follow the above instructions or proper maintenance may void warranty.

ROAD TESTING:

1. Start the engine with the transmission in neutral or park, and the parking brake engaged. Listen for air leaks or odd noises. For air leaks secure hoses and connections. For odd noises, find cause and repair before proceeding. This kit will function identically to the factory system except for being louder and much more responsive.

2. Test drive the vehicle. Listen for odd noises or rattles and fix as necessary.

3. If road test is fine, you can now enjoy the added power and performance from your kit.

4. K&N Engineering, Inc., requires cleaning the intake system's air filter element every 100,000 miles. When used in dusty or off-road environments, our filters will require cleaning more often. We recommend that you visually inspect your filter once every 25,000 miles to determine if the screen is still visible. When the screen is no longer visible some place on the filter element, it is time to clean it. To clean and re-oil, purchase our filter Recharger® service kit, part number 99-5050 or 99-5000 and follow the easy instructions.

INTAKE SYSTEMS FOR VEHICLES LISTED ARE 50 STATE LEGAL. SEE KNFILTERS.COM FOR CARB STATUS ON EACH PART FOR A SPECIFIC VEHICLE.