



INTAKE SYSTEMS FOR VEHICLES LISTED ARE 50 STATE LEGAL. SEE KNFILTERS.COM FOR CARB STATUS ON EACH PART FOR A SPECIFIC VEHICLE.

INSTALLATION INSTRUCTIONS

57-7000
PORSCHE
1999-05 911
H6-3.4L / 3.6L

TOOLS NEEDED:

- | | |
|--------------------|------------------------|
| 5/32" allen wrench | 4mm allen wrench |
| 3/8" drill bit | 13mm socket |
| 3/4" drill bit | 10mm wrench |
| 1/2" socket | drill |
| 7/16" wrench | flat blade screwdriver |
| 2.5mm allen wrench | ratchet |

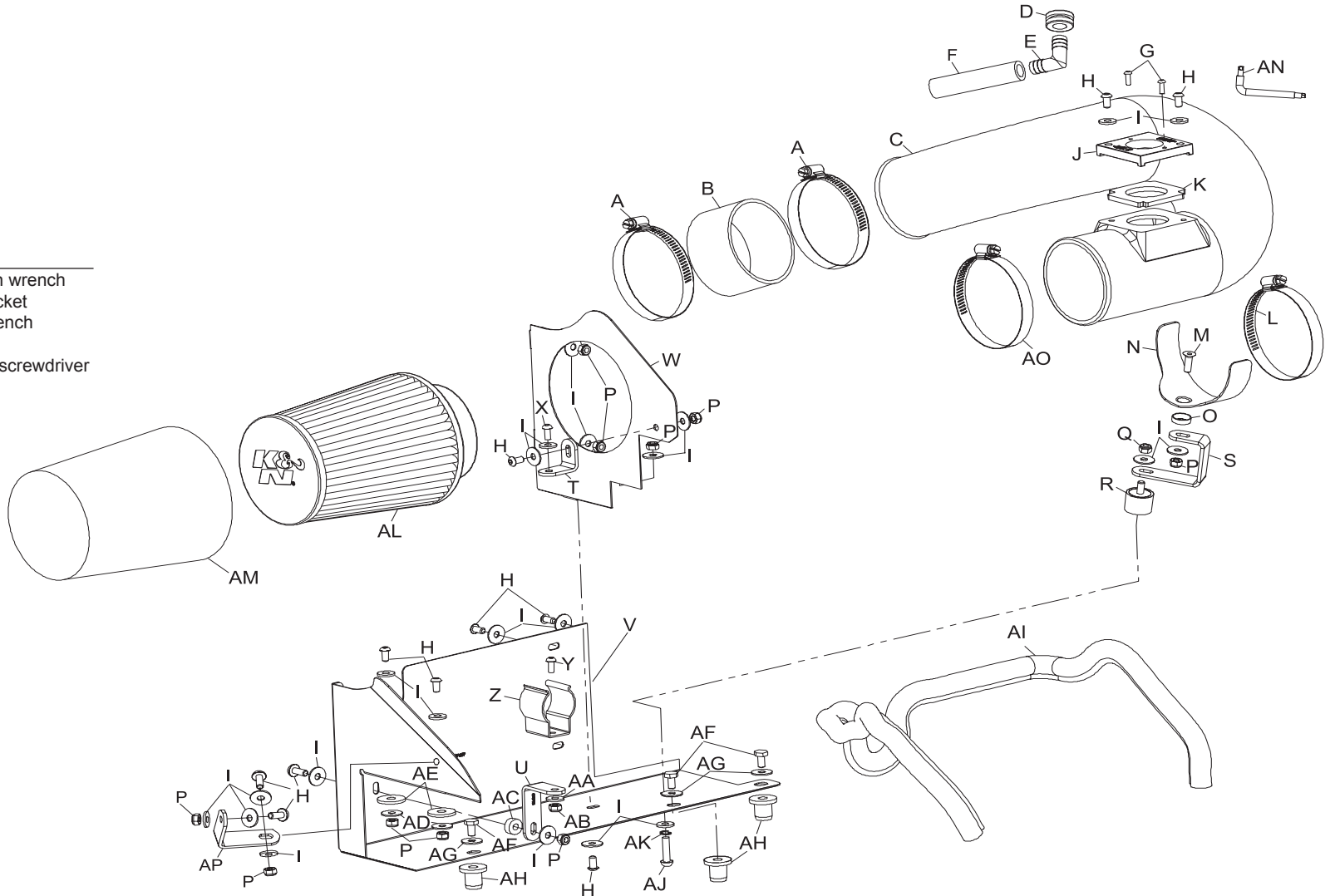

PARTS LIST:

Description	Qty.	Part #
A Hose Clamp, #48	2	08601
B Hose; 3.25"ID x 2"L, Silicone	1	08690
C Intake Tube	1	087190
D Grommet	1	08064
E Hose Mender; 1/2' x 1/2", 90°	1	08065
F Hose; 1/2"ID x 3.5"L, Silicone	1	087028
G Bolt; M4-.7 x 12, B/H/A, SS	2	07726
H Bolt; M6x1.00x16mm, B/H/A	11	07730
I Washer; M6, Flat	22	08269
J Adapter #440	1	21517
K Gasket	1	09074
L Hose Clamp, #52	1	08610
M Bolt; 6mm-1.00x20mm F/H/A	1	08376
N Saddle Bracket	1	078855
O Cup Washer	1	08180
P Nut; 6mm Nylock	10	07553
Q Nut; 1/4-20 Nylock	1	07517
R Stud; 1/4-20 M/F, 3/4 Thk.	1	070226
S "C" Bracket	1	07116
T "L" Bracket, Short	1	070066
U "L" Bracket, Long	1	07093
V Heat shield	1	07669
W heat shield	1	07670
X Bolt; m6-1.00x25mm b/h/a	1	07729
Y Bolt; m5-0.8x12mm b/h/a	1	07734
Z Clamp	1	08308
AA Washer; 5mm flat	1	08212
AB Nut; M5-0.8 Nylock	1	07507
AC Spacer;.625"odx.250"idx.250"L	1	06555
AD Washer; 1"OD X 1/4"ID	2	08160
AE Washer; 1" x .300 x .100	2	21685
AF Bolt; 5/16"- 18 x 1"L, SS	3	07777
AG Washer; 5/16"ID x 5/8"OD,	3	08276
AH Insert; 5/16-18x.600ODX.730L	3	088002
AI Edge Trim 35"	1	102471
AJ Bolt; 1/4-20 x 1/2" B/H/A, SS	1	07706
AK Washer; 1/4"ID Split Lock	1	08198
AL Air Filter	1	RP-4630
AM Drycharger®	1	RC-4630DK
AN Wrench; Torx T20, L-Key	1	69801
AO Hose Clamp #60	1	08624
AP Bracket	1	010040

NOTE: FAILURE TO FOLLOW INSTALLATION INSTRUCTIONS AND NOT USING THE PROVIDED HARDWARE MAY DAMAGE THE INTAKE TUBE, THROTTLE BODY AND ENGINE.

TO START:

1. Turn off the ignition and disconnect the negative battery cable.

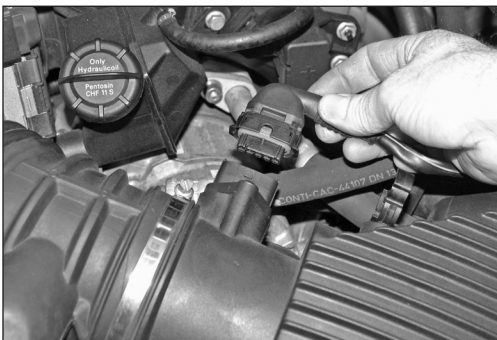

2. Depress the locking tab and disconnect the mass air sensor electrical connection. Unclip the mass air sensor wiring harness from the air box.



3. On "TIPTRONIC" equipped vehicles with a vent line connected to the stock intake tube next to the throttle body, loosen the hose clamp that secures the vent line and disconnect the vent line from the intake tube.

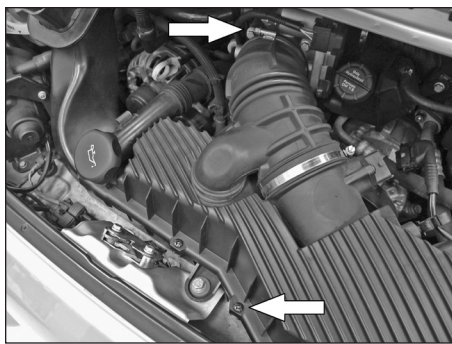

4. Loosen the hose clamp, which secure intake tube to the throttle body, and remove the air box mounting bolt shown.



5. Remove the complete air box assembly from the vehicle as shown.
NOTE: K&N Engineering, Inc., recommends that customers do not discard factory air intake.

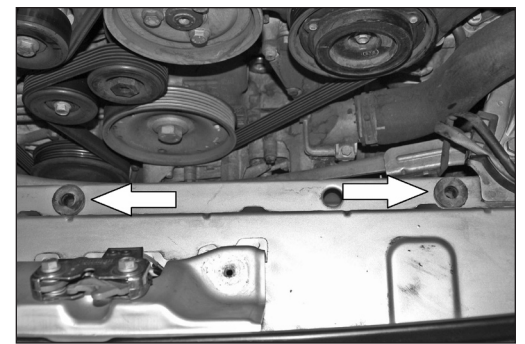

6. Remove the two air box mounting grommets shown.

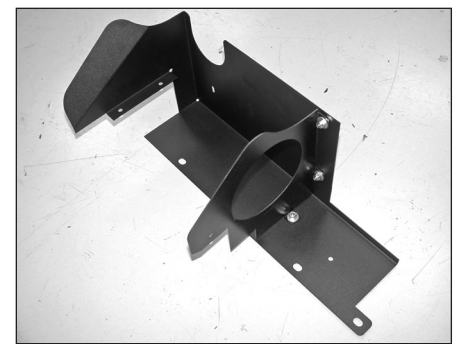

7. Install the heat shield wall (07670) onto the main heat shield with the hardware provided.

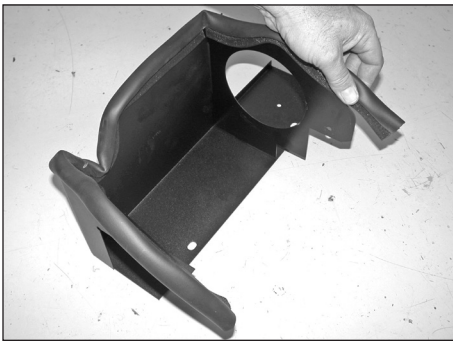

8. Install the edge trim onto the heat shield as shown.
Note: Some trimming of the edge trim will be necessary.

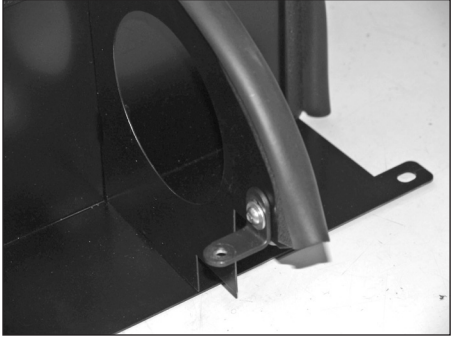

9. Install the small "L" bracket (070066) onto the heat shield with the hardware provided.
NOTE: The slotted end of the bracket attaches to the heat shield.

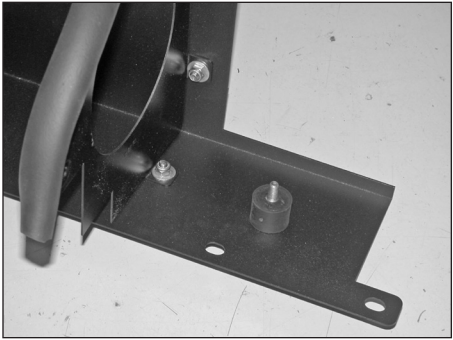

10. Install the rubber mounted stud onto the heat shield as shown using the hardware provided.



11. Install the oil fill tube retaining clip onto the "L" bracket (07093) with the hardware provided as shown.



12. Using the spacer and hardware provided, install the oil filler tube retaining assembly onto the heat shield as shown.
NOTE: The spacer is installed between the heat shield and bracket.



13. Install the "C" bracket (07116) onto the saddle clamp using the hardware as shown.

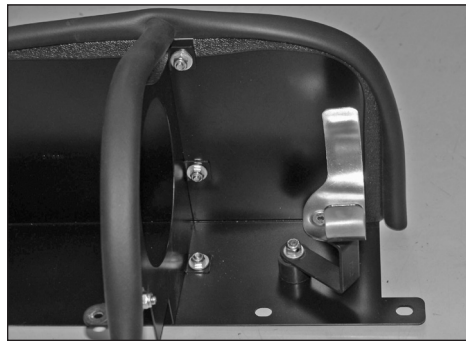

14. Install the saddle clamp assembly onto the rubber mounted stud on the heat shield with the hardware provided as shown.

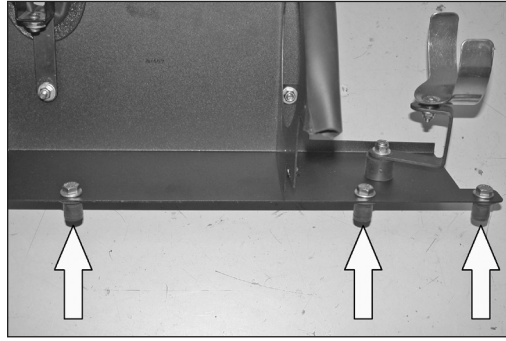

15. Install the inserted nuts onto the heat shield using the provided hardware.
NOTE: On some early model vehicles, the middle inserted nut is not used.

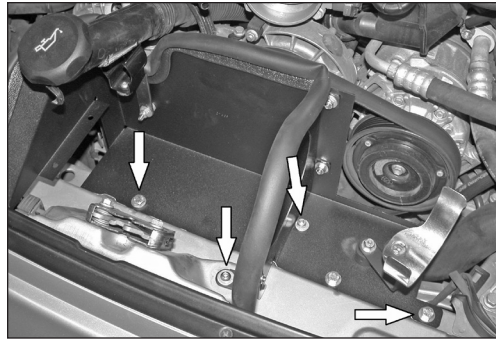

16. Install the heat shield assembly into the vehicle so that the inserted nuts go into the 3/4" air box mounting holes in the body. Tighten the mounting bolts and install the supplied mounting bolt through the "L" bracket into the body and tighten.

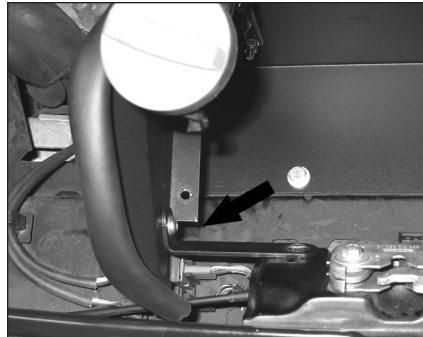

16a. Align the "L" bracket (010040) with the heat shield and secure with the provided hardware as shown.



16b. Using a marker, mark the bolt hole location on the hood latch support bracket as shown.

NOTE: Be sure the hole location will not interfere with the latch release cable and/or wires before drilling.

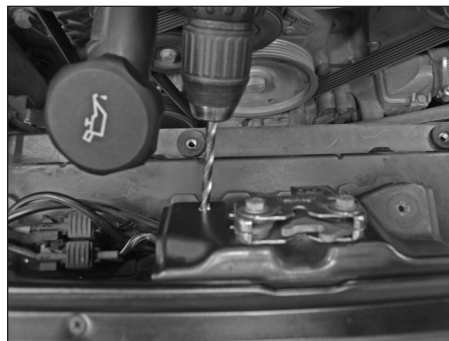

16c. Drill a 1/4" id hole into the hood latch support at the location marked in step 16b.

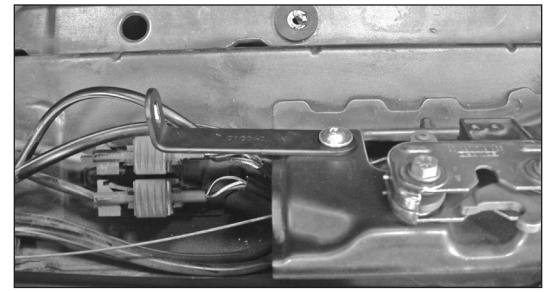

16d. Install the "L" bracket (010040) onto the hood latch support and secure with the provided hardware as shown.

NOTE: Do not completely tighten the bracket at this time.



16e. Reinstall the heat shield assembly and secure with the provided inserted nuts and "L" bracket (070066). Secure the "L" bracket to body with the provided hardware.



16f. Secure the heat shield to the "L" bracket (010040) installed in step 16e with the provided hardware.

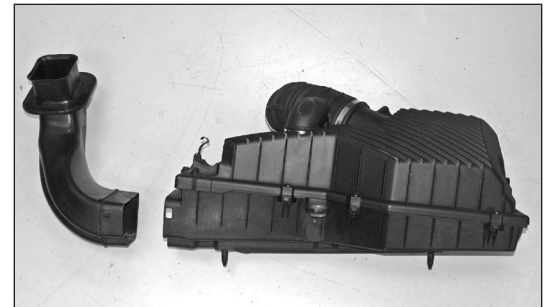

17. Remove the fresh air supply duct from the factory air box as shown.



18. Install the fresh air supply duct into the heat shield and align duct so that it lines up with the bellows on the hood and with the heat shield as shown.



19. Mark the location of the holes in the heat shield on the fresh air supply duct as shown.

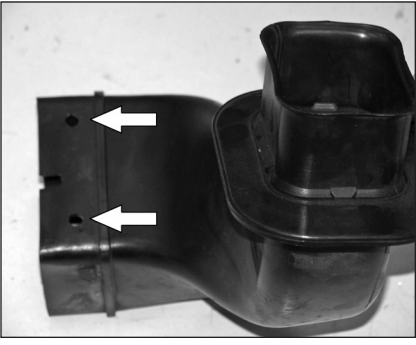

20. Drill two 3/8" id holes at the marked location on the fresh air supply duct.



21. Using the hardware provided, bolt the fresh air supply duct to the heat shield as shown.



22. Install the silicone hose (08690) onto the throttle body and secure with the hose clamp provided.

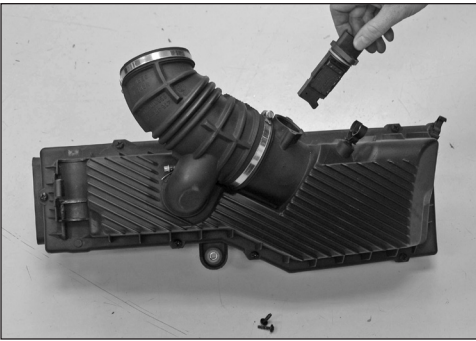

23. Using the T20 Torx wrench provided, remove the two screws, which secure the mass air sensor to the stock intake assembly. Remove the mass air sensor from the stock intake as shown.

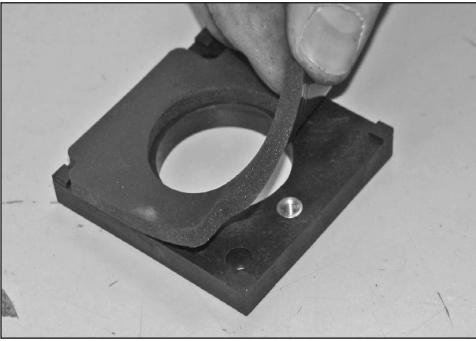

24. Install the supplied gasket onto the mass air adapter plate as shown.

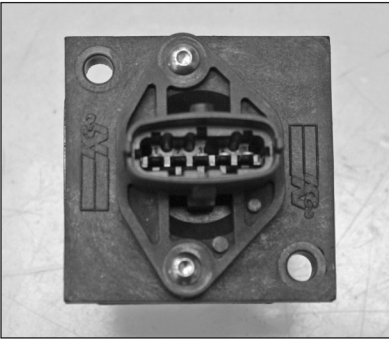

25. Using the hardware provided, install the mass air sensor onto the adapter plate as shown.

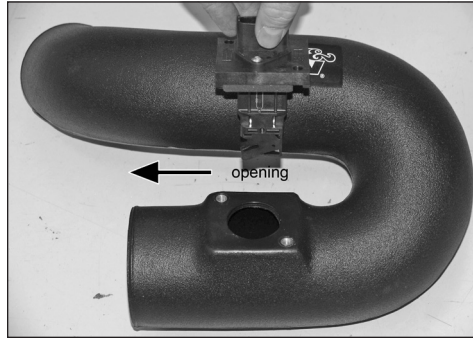

26. Install the mass air sensor assembly into the K&N® intake tube as shown and secure with the provided hardware.

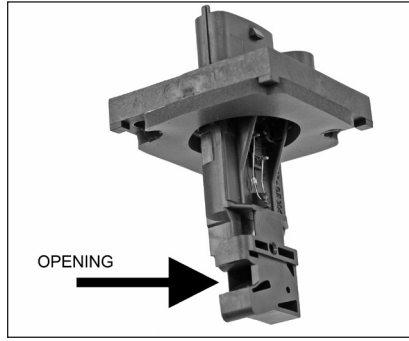

26a. Be sure to install the mass air sensor with the opening towards the filter end of the tube.

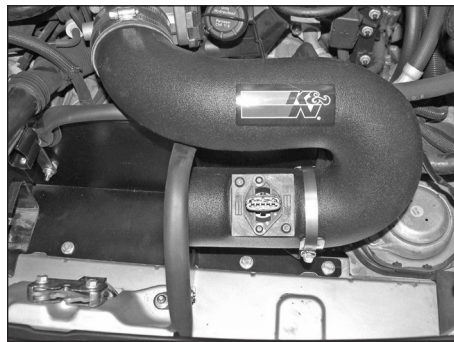

27. Install the K&N® intake tube onto the throttle body and saddle clamp, secure with the provided hose clamps.



28. On vehicles with "TIPTRONIC" equipped vehicles, install the supplied silicone hose onto the 90° hose mender as shown.

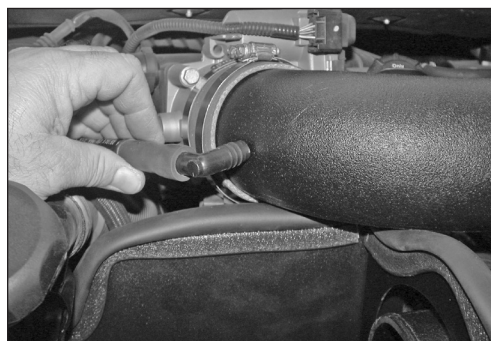

29. On "TIPTRONIC" equipped vehicles, install the 90° vent fitting assembled in step #28 onto the vent line and align it with the K&N® intake tube for best fit, place a mark on the tube for a drill location.



30. Remove the K&N® intake tube from the vehicle and drill a 3/4" hole at the marked location. Install the supplied grommet into the drilled hole. Be sure there are no shavings in the intake tube and then reinstall the K&N® intake tube into the vehicle and secure with the provided hose clamps.



31. Install the 90° hose mender into the grommet installed in step #30 as shown.



32. Pull the rubber wiring harness boot back from the mass air sensor electrical connection, rotate the connector 180° and reinstall the boot.



33. Connect the mass air sensor electrical connection as shown.



34. Install the supplied K&N® Drycharger® onto the K&N® filter as shown.

NOTE: Please be aware the Drycharger® is water repellent, not water proof. Depending on conditions and usage the water repellent treatment is good for 1 to 2 years. See the parts list to reorder a new Drycharger® if necessary.



35. Install the K&N® filter onto the intake tube and secure with the provided hose clamp. Snap the stock oil fill tube into the retaining clip.

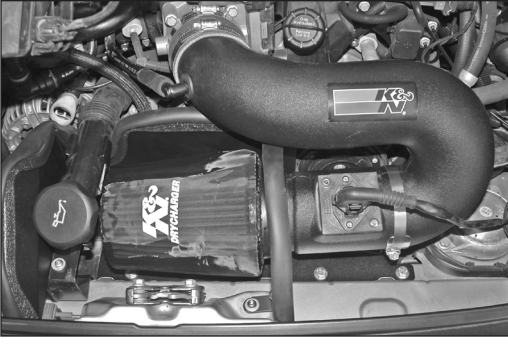

36. Reconnect the vehicle's negative battery cable. Double check to make sure everything is tight and properly positioned before starting the vehicle.

WARNING: Please follow these installation instructions carefully. The K&N® Drycharger® included with this kit must be installed on the K&N® air filter when used with a K&N high flow intake system. The high flow intake system is a performance product that can be used safely during mild weather conditions. During harsh and inclement weather conditions, you must return your vehicle to stock OEM airbox and intake tract configuration. Failure to follow these instructions will void your warranty.

37. The C.A.R.B. exemption sticker, (attached), must be visible under the hood, so the emissions inspector can see it when the vehicle is required to be tested for emissions. California requires testing every two years, other states may vary.

38. It will be necessary for all K&N® high flow intake systems to be checked periodically for realignment, clearance and tightening of all connections. Failure to follow the above instructions or proper maintenance may void warranty.

ROAD TESTING:

1. Start the engine with the transmission in neutral or park, and the parking brake engaged. Listen for air leaks or odd noises. For air leaks secure hoses and connections. For odd noises, find cause and repair before proceeding. This kit will function identically to the factory system except for being louder and much more responsive.

2. Test drive the vehicle. Listen for odd noises or rattles and fix as necessary.

3. If road test is fine, you can now enjoy the added power and performance from your kit.

4. K&N Engineering, Inc., suggests checking the air filter element periodically for excessive dirt build-up. When the element becomes covered in dirt (or once a year), service it according to the instructions on the Recharger® service kit, part number 99-5050 or 99-5000.

INTAKE SYSTEMS FOR VEHICLES LISTED ARE 50 STATE LEGAL. SEE KNFILTERS.COM FOR CARB STATUS ON EACH PART FOR A SPECIFIC VEHICLE.

* FREE K&N® decal To register your warranty, please see us online at knfilters.com/register. FREE K&N® decal *