



INTAKE SYSTEMS FOR VEHICLES LISTED ARE 50 STATE LEGAL. SEE KNFILTERS.COM FOR CARB STATUS ON EACH PART FOR A SPECIFIC VEHICLE.

INSTALLATION INSTRUCTIONS

57-2528

Ford

1997-00 Explorer

***2001 Explorer Sport Track**

V6-4.0L SOHC

*Models with production date up to 7/24/00

NOTE: This kit was not designed to fit vehicles with a body lift

TOOLS NEEDED:

- Flat blade screwdriver
- 5mm allen wrench
- 4mm allen wrench
- 10mm wrench
- 13mm wrench

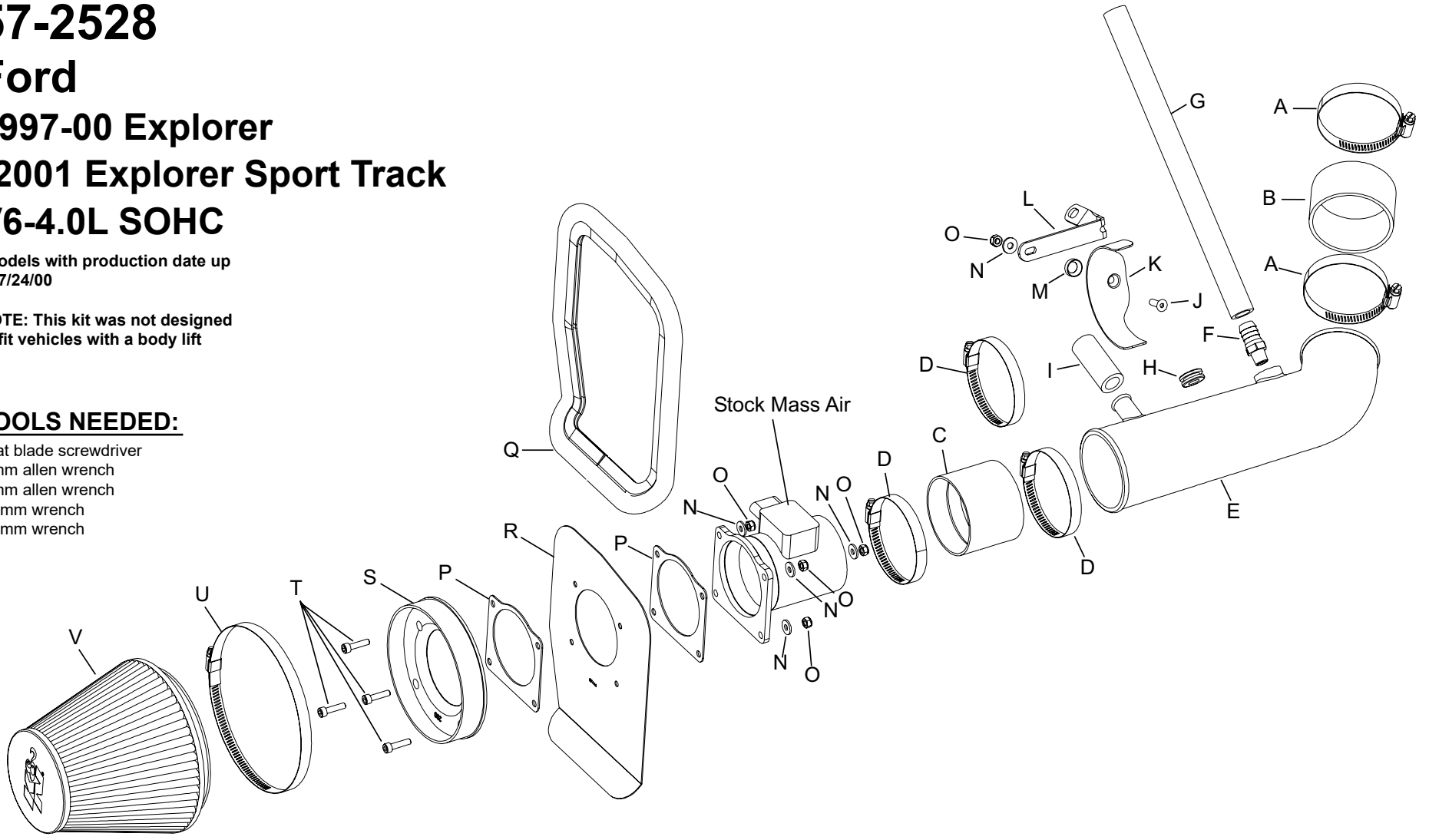

PARTS LIST:

Description	Qty.	Part #	Description	Qty.	Part #	Description	Qty.	Part #
A HOSE CLAMP; #44	2	08577	I HOSE; 3/4"ID X 2.25"L	1	08709	Q EDGE TRIM; 33"L	1	102498
B HOSE; 3"ID X 1.75"L	1	08190	J BOLT; M6-1.00 X 20MM	1	08376	R HEAT SHIELD	1	07444
C HOSE; 3.25"ID X 2"L	1	08690	K BRACKET; SADDLE	1	078855	S ADAPTER; 6"OD #200	1	08831
D HOSE CLAMP; #48	3	08601	L BRACKET	1	26605	T BOLT; M6-1.00 X 25MM	4	07859
E INTAKE TUBE; (BL)	1	087015A	M WASHER; CONICAL, NYLON	1	08180	U HOSE CLAMP; #104	1	08697
F FITTING; VENT, 1/4"NPT	1	82638	N WASHER; 1/4"ID X 5/8"OD	5	08275	V AIR FILTER	1	RU-1048
G HOSE; 5/8"ID X 13"L	1	08602	O NUT; 6MM NYLOCK	5	07553			
H GROMMET; 7/16"OD	1	08092	P GASKET; 1/16"THK	2	09330			

NOTE: FAILURE TO FOLLOW INSTALLATION INSTRUCTIONS AND NOT USING THE PROVIDED HARDWARE MAY DAMAGE THE INTAKE TUBE, THROTTLE BODY AND ENGINE.

TO START:

1. Turn off the ignition and disconnect the negative battery cable.
NOTE: Disconnecting the negative battery cable erases pre-programmed electronic memories. Write down all memory settings before disconnecting the negative battery cable. Some radios will require an anti-theft code to be entered after the battery is reconnected. The anti-theft code is typically supplied with your owner's manual. In the event your vehicles' anti-theft code cannot be recovered, contact an authorized dealership to obtain your vehicles anti-theft code.

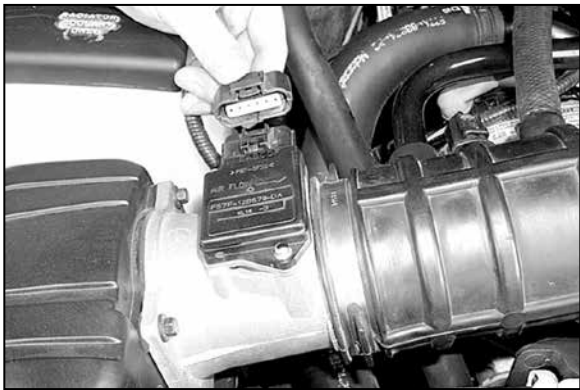

2. Disconnect the mass air sensor electrical connection.

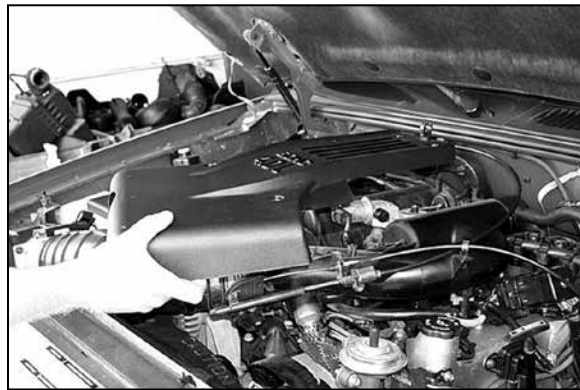

3. Remove the factory engine cover.

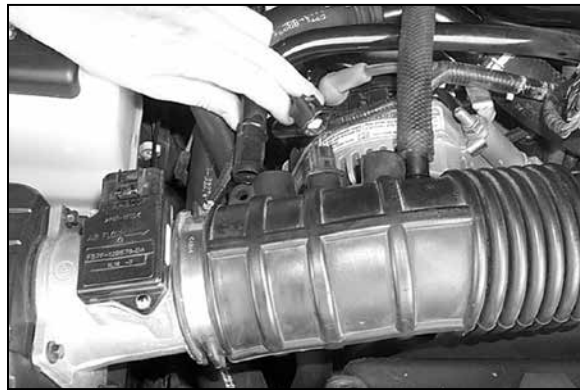

4. Remove the IAC vent, temp sensor and the CVC hose as shown

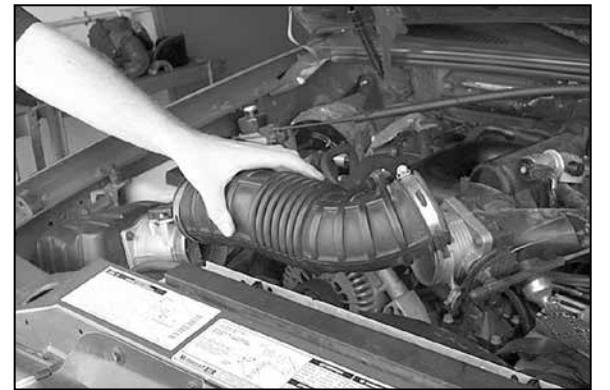

5. Loosen the hose clamps at the throttle body and the mass air sensor, then remove the air intake tube as shown



6. Using a screw driver, pry the air cleaner assembly upwards to release the air cleaner from the factory grommets, then remove the air cleaner assembly.



7. Loosen and remove the 4 bolts that secure the mass air sensor then remove the mass air sensor as shown.

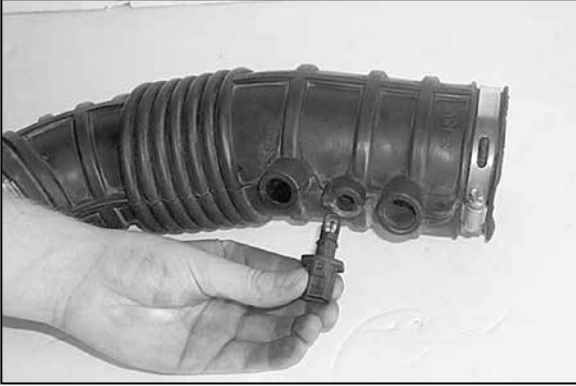

8. On vehicles equipped with an air temp sensor, remove from factory air intake tube.

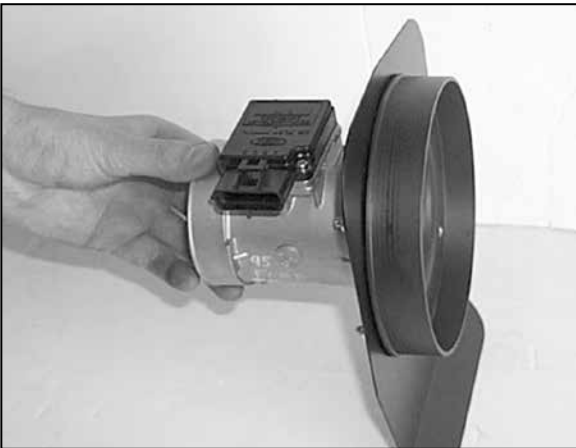

9. Using the provided hardware, assemble the mass air adapter, gasket, heat shield and the mass air sensor as shown.



10. Install the trim seal onto the heat shield assembly as shown.



11. Install the silicone hose and hose clamps onto the heat shield assembly as shown.



12. Install the silicone hose and hose clamps onto the throttle body as shown.

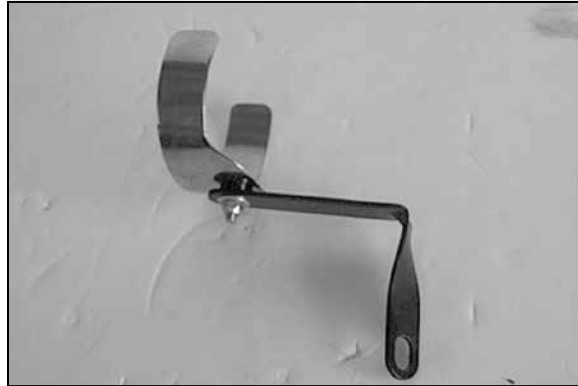

13. Using the hardware, assemble the saddle bracket assembly as shown.



14. Remove the factory alternator stud and install the saddle bracket assembly using the factory stud as show.

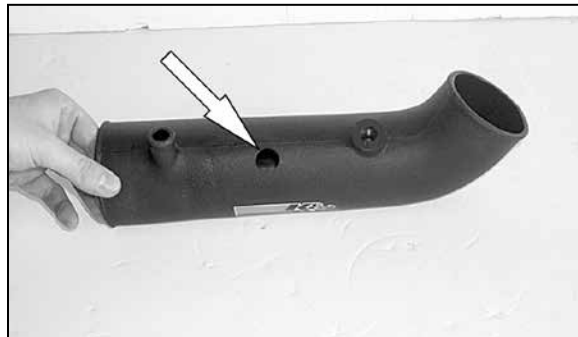

15. On vehicles equipped with an air temp sensor, drill an 11/16" hole on the drill point located on the tube.



16. On vehicles equipped with an air temp sensor, install the provided grommet into the hole from step 15.

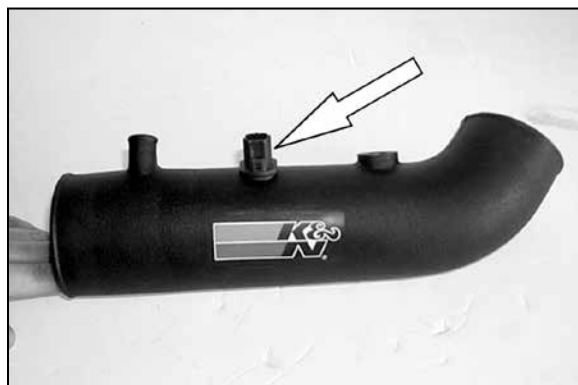

17. Install the air temp sensor into the grommet as shown.

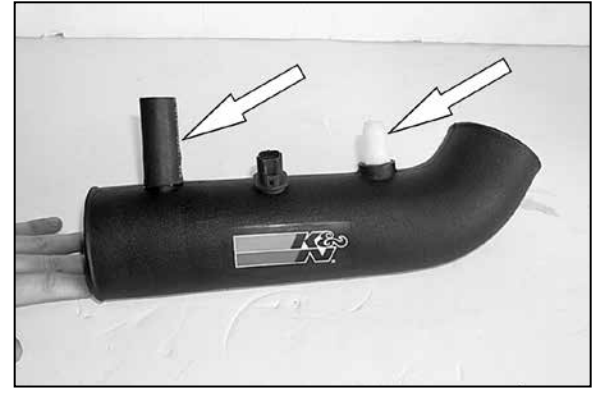

18. Install the rubber hose and 5/8" barbed vent onto the K&N® intake tube as shown.

NOTE: NPT fitting has tapered threads and only designed to be installed until hand tight, then tighten one rotation or when the fitting becomes difficult to return.



19. Install the K&N® intake tube onto the throttle body as shown.



20. Secure the K&N® intake tube to the saddle bracket assembly with the provided hose clamp as shown.

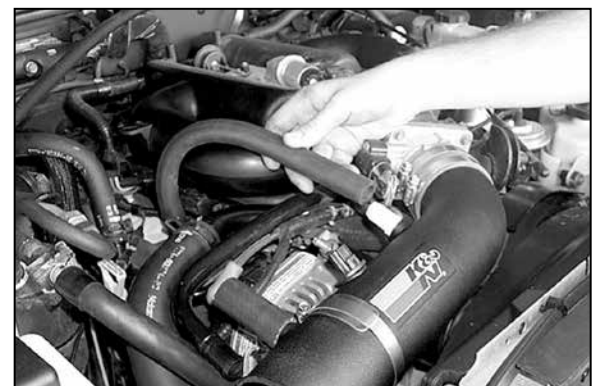

21. Remove the factory CCV hose from the valve cover and install the provided silicone hose onto the valve cover then secure the other end to the K&N® intake tube as shown.



22. Reconnect the air temp sensor electrical connection and the IAC vent hose as shown.



23. Install the K&N Filtercharger onto the heat shield assembly as shown.

NOTE: Drycharger® air filter wrap; part # RF-1048DK is available to purchase separately. To learn more about Drycharger® filter wraps or look up color availability please visit <http://www.knfilters.com>.



24. Install the heat shield assembly onto the K&N intake tube and tighten the hose clamp as shown



25. Reconnect the mass air sensor electrical connection.

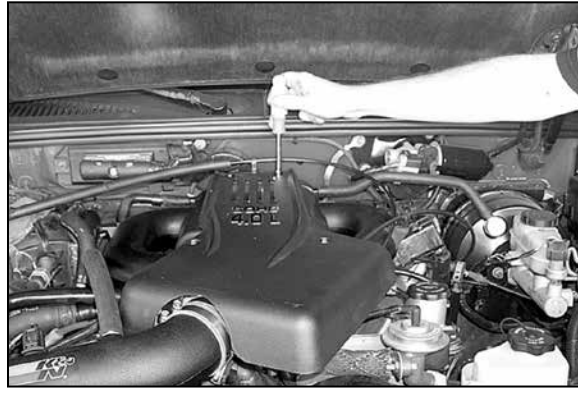

26. Reinstall the factory engine cover.

27. Reconnect the vehicle's negative battery cable. Double check to make sure everything is tight and properly positioned before starting the vehicle.

28. The C.A.R.B. exemption sticker, (attached), must be visible under the hood so that an emissions inspector can see it when the vehicle is required to be tested for emissions. California requires testing every two years, other states may vary.

29. It will be necessary for all K&N® high flow intake systems to be checked periodically for realignment, clearance and tightening of all connections. Failure to follow the above instructions or proper maintenance may void warranty.

ROAD TESTING:

1. Start the engine with the transmission in neutral or park, and the parking brake engaged. Listen for air leaks or odd noises. For air leaks secure hoses and connections. For odd noises, find cause and repair before proceeding. This kit will function identically to the factory system except for being louder and much more responsive.

2. Test drive the vehicle. Listen for odd noises or rattles and fix as necessary.

3. If road test is fine, you can now enjoy the added power and performance from your kit.

4. K&N Engineering, Inc., requires cleaning the intake system's air filter element every 100,000 miles. When used in dusty or off-road environments, our filters will require cleaning more often. We recommend that you visually inspect your filter once every 25,000 miles to determine if the screen is still visible. When the screen is no longer visible some place on the filter element, it is time to clean it. To clean and re-oil, purchase our filter Recharger® service kit, part number 99-5050 or 99-5000 and follow the easy instructions.

INTAKE SYSTEMS FOR VEHICLES LISTED ARE 50 STATE LEGAL. SEE KNFILTERS.COM FOR CARB STATUS ON EACH PART FOR A SPECIFIC VEHICLE.