



INSTALLATION GUIDE: AWE EXHAUST SUITE FOR THE AUDI 8Y S3

For up-to-date fitment information, please visit the product page on [AWE-Tuning.com](https://www.awe-tuning.com).

THIS GUIDE IS INTENDED FOR THE FOLLOWING PART NUMBERS:

- 3020-42897 AWE Track Edition Exhaust for Audi 8Y S3 - Chrome Silver Tips
- 3020-43897 AWE Track Edition Exhaust for Audi 8Y S3 - Diamond Black Tips
- 3015-42897 AWE Touring Edition Exhaust for Audi 8Y S3 - Chrome Silver Tips
- 3015-43897 AWE Touring Edition Exhaust for Audi 8Y S3 - Diamond Black Tips
- 3820-11897 AWE Touring-to-Track Conversion Kit for Audi 8Y S3
- 3815-11897 AWE Track-to-Touring Conversion Kit for Audi 8Y S3

Welcome to the AWE family, and congratulations on your purchase of the AWE Exhaust System for the Audi 8Y S3.

Exquisite build quality and craftsmanship, coupled with industry leading performance, distinguish this exhaust system from all others.

*For up to the minute fitment information, be sure to visit the AWE website. As always, AWE Performance Specialists are standing by for any questions, [right here](#).

PARTS LIST (TOURING SYSTEMS)



Inspect **ALL** parts prior to disassembly of vehicle; If damaged or **MISSING**, please contact the place of purchase immediately.

Symbol	Part Number	Description	QTY
	LG	MK7 GTI Exhaust, OE Inlet adapter	1
	F97	MK8 Golf R Muffler Inlet Section	1
	F98	MK8 Golf R Muffler Touring Rear Section	1
	G13	8Y Audi S3 DS Tip Section	1
	G14	8Y Audi S3 PS Tip Section	1
A >>	180300	AWE 3.0" Band Clamp, Stainless	2
B >>	180250	AWE 2.5" Band clamp, stainless	2
C >>	3910-11012	AWE 1/2" Split Collar Clamp Kit	1
D >>	3910-41010	Hardware Kit for Integrated Clamp Style Exhaust Tips - Quad	1
E >>	7130K59	7.5 INCH ZIP TIE (MEDIUM)	4
F >>	GA-6669	Electronic Valve Simulator	2
G >>	180014	77mm Inlet, 114mm OD, Integrated clamp, Chrome Silver	4
	180015	4.50" OD x 3.00" ID, Slash Cut, Diamond Black, AWE Logo, Inter-grated Clamp	4

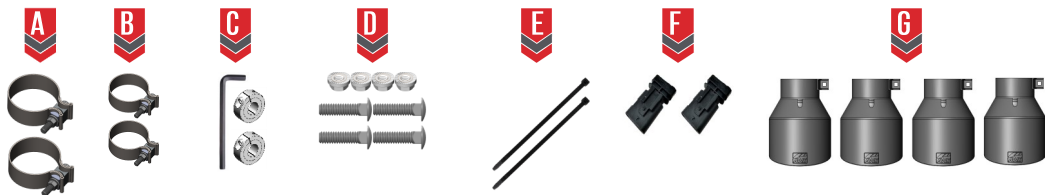
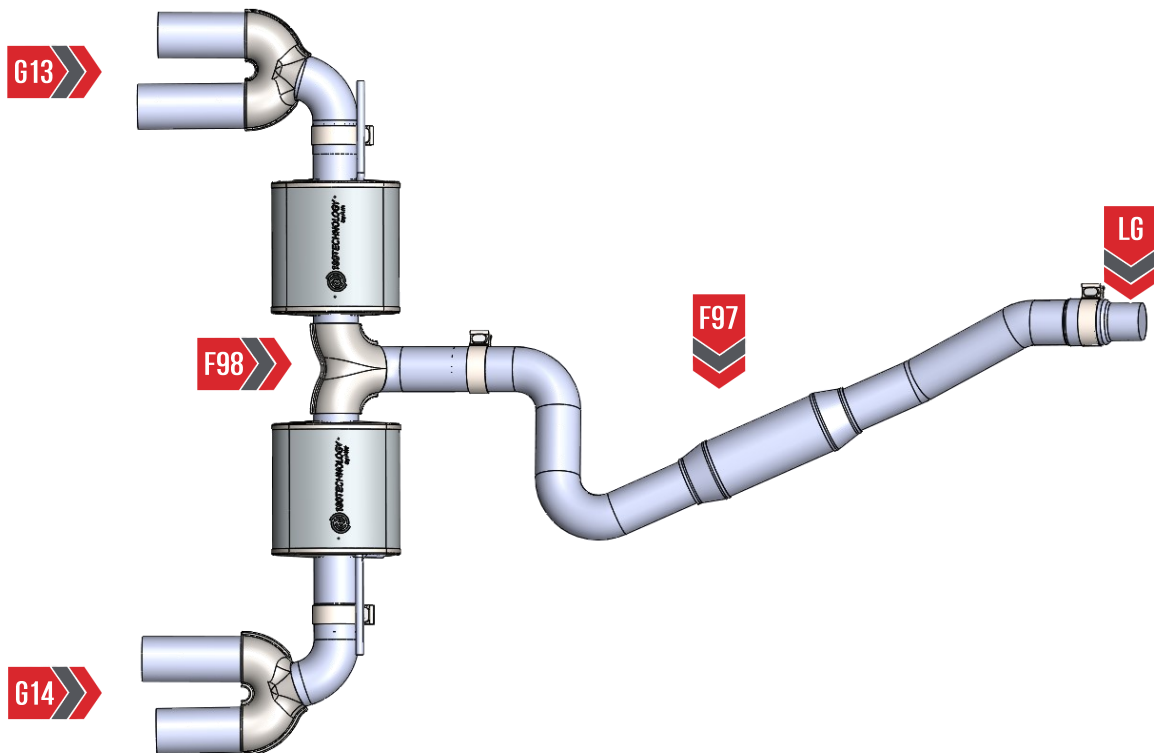

PARTS LIST (TRACK SYSTEMS)



Inspect **ALL** parts prior to disassembly of vehicle; If damaged or **MISSING**, please contact the place of purchase immediately.

Symbol	Part Number	Description	QTY
	LG	MK7 GTI Exhaust, OE Inlet adapter	1
	F97	MK8 Golf R Muffler Inlet Section	1
	F99	MK8 Golf R Track Rear Section	1
	G13	8Y Audi S3 DS Tip Section	1
	G14	8Y Audi S3 PS Tip Section	1
A >>	180300	AWE 3.0" Band Clamp, Stainless	2
B >>	180250	AWE 2.5" Band clamp, stainless	2
C >>	3910-11012	AWE 1/2" Split Collar Clamp Kit	1
D >>	3910-41010	Hardware Kit for Integrated Clamp Style Exhaust Tips - Quad	1
E >>	7130K59	7.5 INCH ZIP TIE (MEDIUM)	4
F >>	GA-6669	Electronic Valve Simulator	2
G >>	180014	77mm Inlet, 114mm OD, Integrated clamp, Chrome Silver	4
G >>	180015	4.50" OD x 3.00" ID, Slash Cut, Diamond Black, AWE Logo, Inter-grated Clamp	4

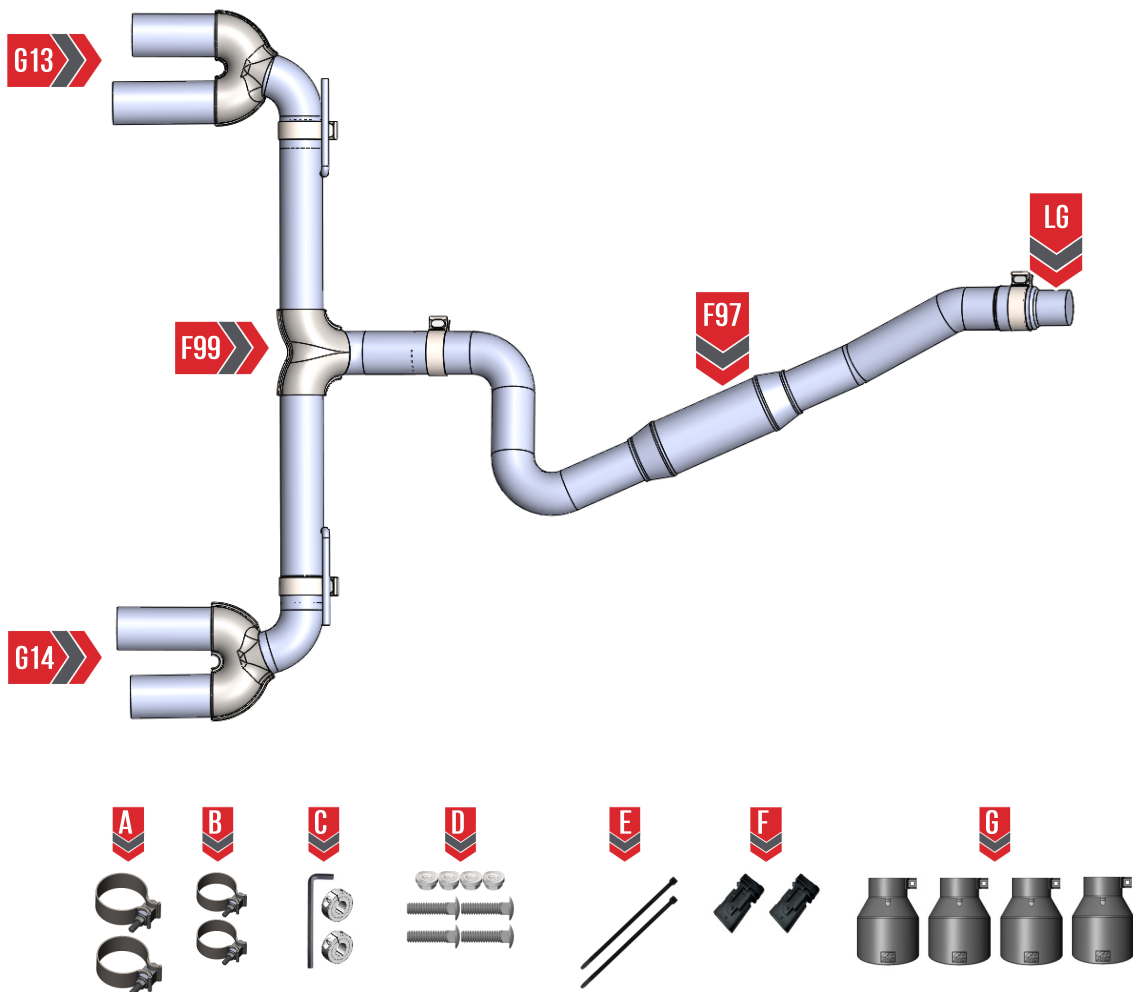



NOTE: Always refer to the manufacturer's service manual for precise torque specifications on all OEM fasteners.



CAUTION: The exhaust may be **VERY HOT** — allow adequate time for the system to cool down before disassembly. Severe burns and injury will occur if skin comes into contact with a hot exhaust system.

STEP 1



Soak all bolts and rubber hangers in penetrating oil before starting any work.

1. Loosen the OE sleeve clamp (**A**), and slide it towards the front of the car.
2. Unplug the 2 OE valve motor wiring harnesses located at (**B**).
3. Remove the OE rubber hangers from the OE hanger bars shown at (**C**).
4. Remove the OE hardware holding the hangers shown at (**D**).
5. Remove the OE Exhaust.

Note: All of the OE rubber hangers, and hardware will be reused with your AWE exhaust.

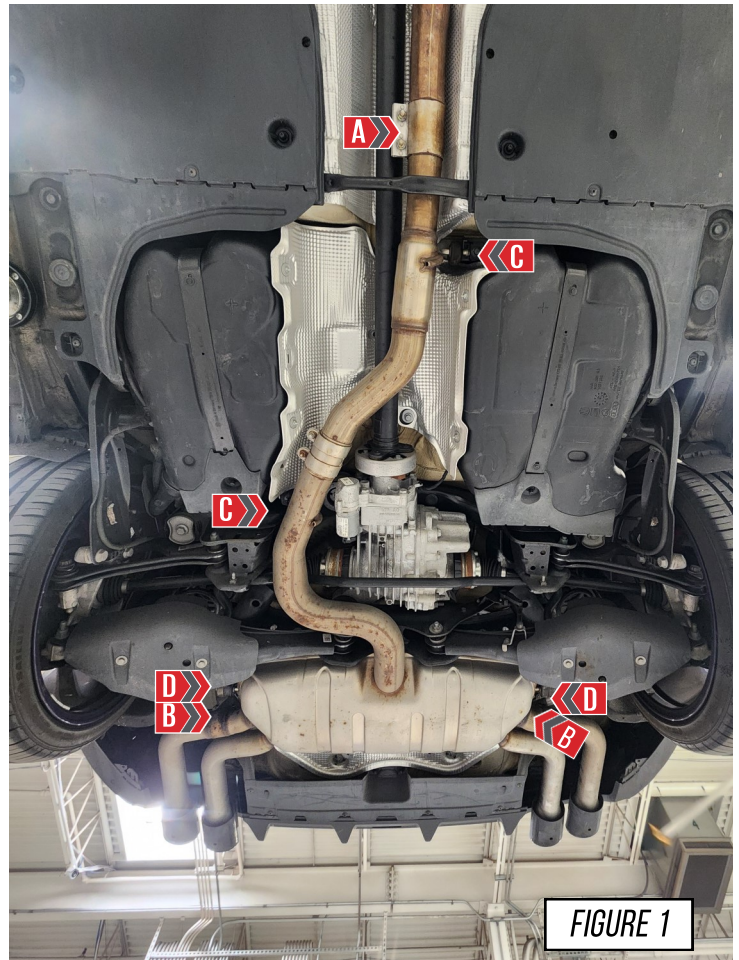

STEP 2

Gather your AWE inlet adapter (**LG**), your AWE muffler inlet section (**F97**), and a provided 3 inch clamp.

Bottom out the expanded side of the inlet adapter on the front side of your muffler inlet section, as shown in **Figure 2**. The front side has a shallow bend with a hanger bar right behind it.

Fully tighten the clamp on the slip fit at this time.



STEP 3

It is crucial to install each section and exhaust band clamps correctly to prevent loose joints, exhaust leaks and rattles.

Arrow A shows the expanded pipe and the preinstalled exhaust clamp being brought up to the corresponding pipe.

Arrow B shows the overlapping pipe installed correctly over the corresponding pipe.

Arrow C shows the exhaust band clamp being brought to the edge of the expanded pipe.



NOTES:

- **Do not** fully torque any exhaust clamp until the entire exhaust has been installed and adjusted.
- Torque specification is a **minimum** of 60 ft/lbs

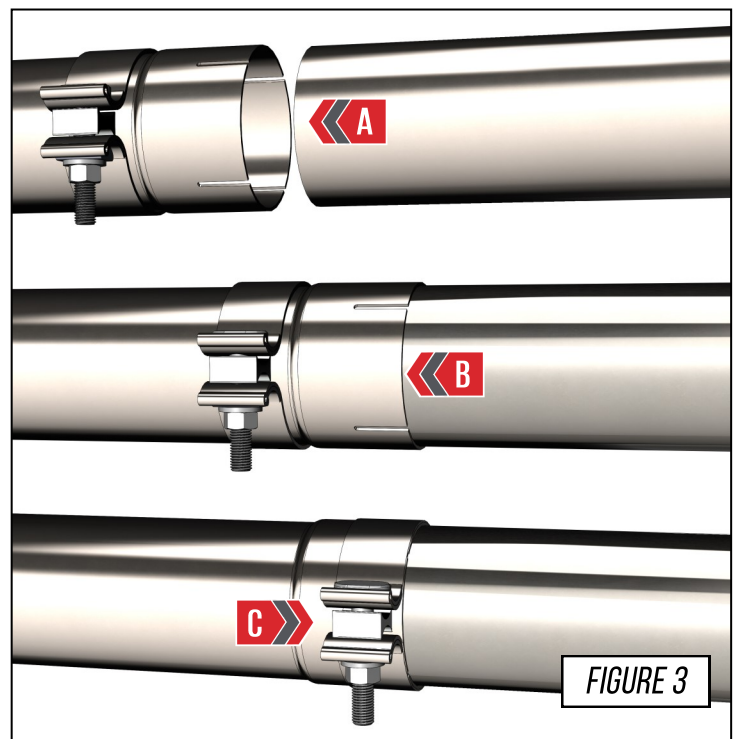

STEP 4

Install your AWE inlet adapter (**LG**), and AWE muffler inlet section (**F97**), as shown in **Figure 4-1**.

Do this by sliding the small side of the inlet adapter into the OE tube, as shown at (**A**) in **Figure 4-1**. Next install the hanger bars into the OE rubber hangers, as shown at (**B**).

To ensure fitment is correct the rear side of the tube should be sitting centered in the tunnel cut out in the subframe, as shown in **Figure 4-2**.

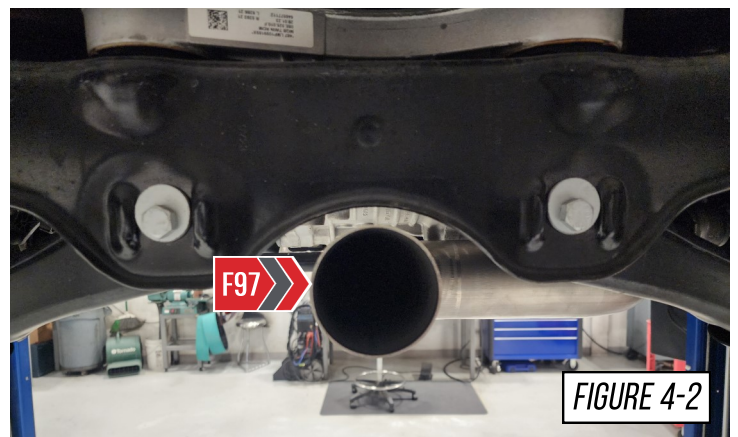
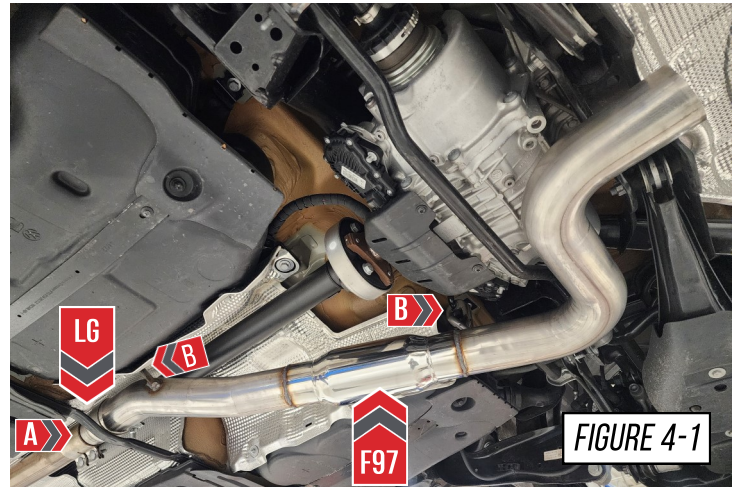

STEP 5

Remove the OE driver, and passenger side hangers from the OE exhaust as shown in **Figure 5-1**, and in **Figure 5-2**.

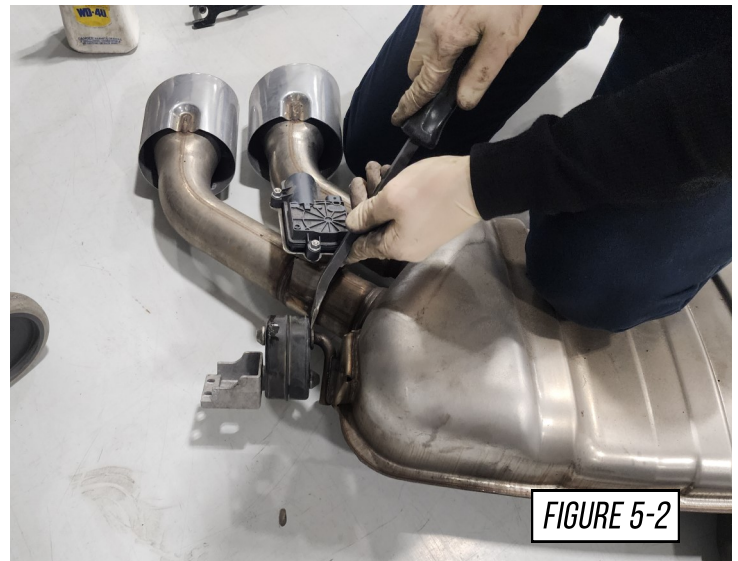
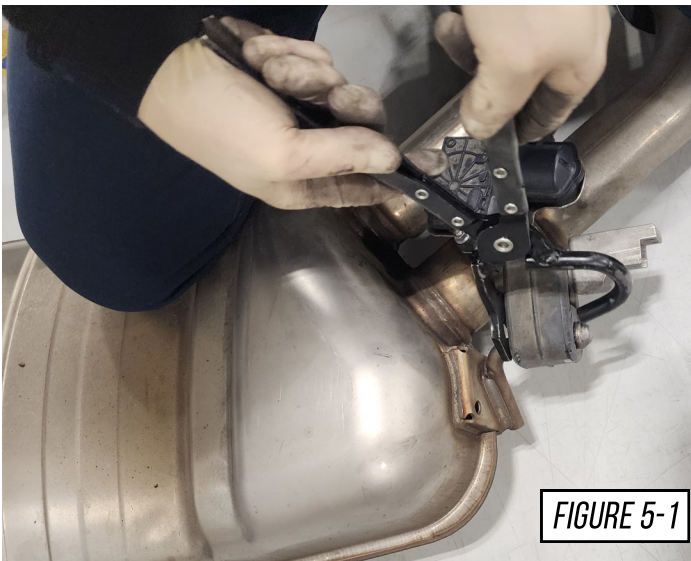

STEP 6

Gather your AWE Track or Touring rear section (**F98/F99**), and slide the OE hangers that were removed in **Step 5** onto the hanger bars, as shown in **Figure 6**.



STEP 7

Install your AWE rear section (**F98/F99**), do this by first sliding a provided 3 inch clamp over the expanded end, and bottom the slip fit on your muffler inlet section (**F97**), as shown in **Figure 7-1**.

Next using the OE hardware reinstall the OE passenger side hanger, as shown in **Figure 7-1**.

Now using the OE hardware reinstall the OE driver side hanger, as shown in **Figure 7-2**.

Snug the clamp on the slip fit but do not fully tighten it at this time.

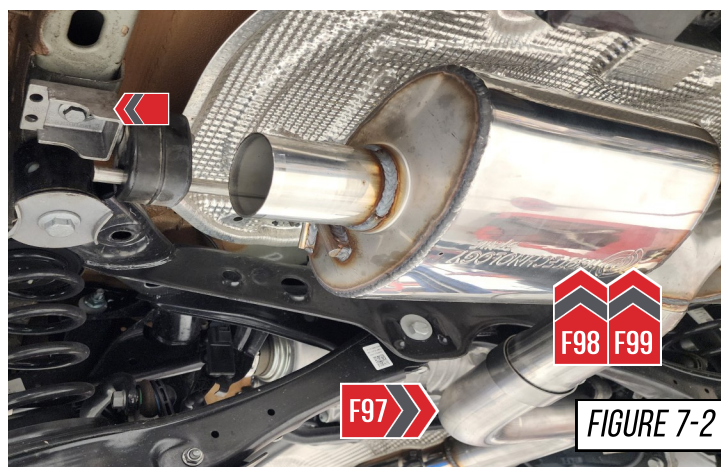
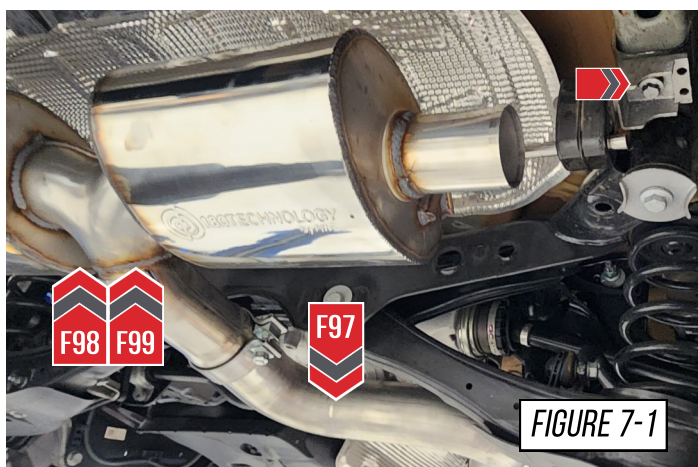

STEP 8

Install your AWE tip sections.

Gather your AWE driver side tip section (**G13**), and a provided 2.5" clamp. Install the tip section centered in the bumper cutout, as shown in **Figure 8-1**. Snug the clamp but do not fully tighten it at this time.

Gather your AWE passenger side tip section (**G14**), and a provided 2.5" clamp. Install the tip section centered in the bumper cutout, as shown in **Figure 8-2**. Snug the clamp but do not fully tighten it at this time.

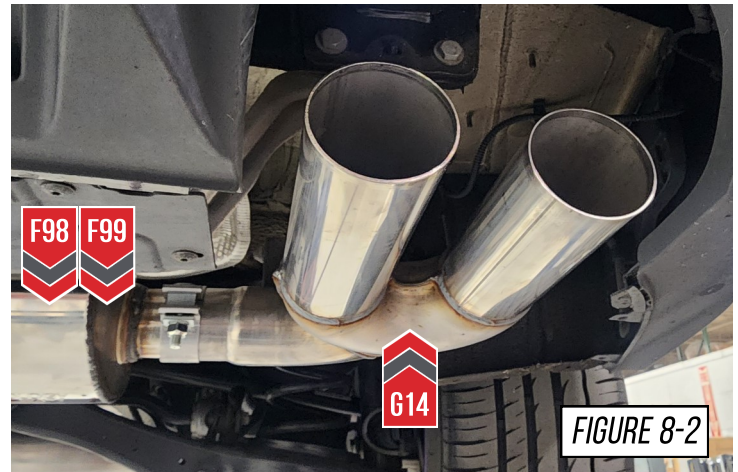
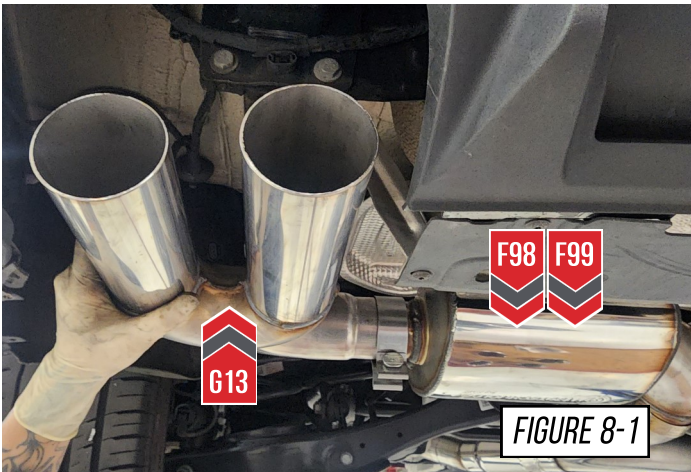

STEP 9

Secure your driver side OE valve harness onto the OE hanger using the OE clip, as shown at (A) in **Figure 9-1**.

Next plug in your AWE valve simulator, and secure it to the OE harness using the provided cable ties, as shown at (B) in **Figure 9-1**.

Now secure your Passenger side OE valve harness onto the OE hanger using the OE clip, as shown at (A) in **Figure 9-2**.

Lastly plug in your AWE valve simulator, and secure it to the OE harness using the provided cable ties, as shown at (B) in **Figure 9-2**.

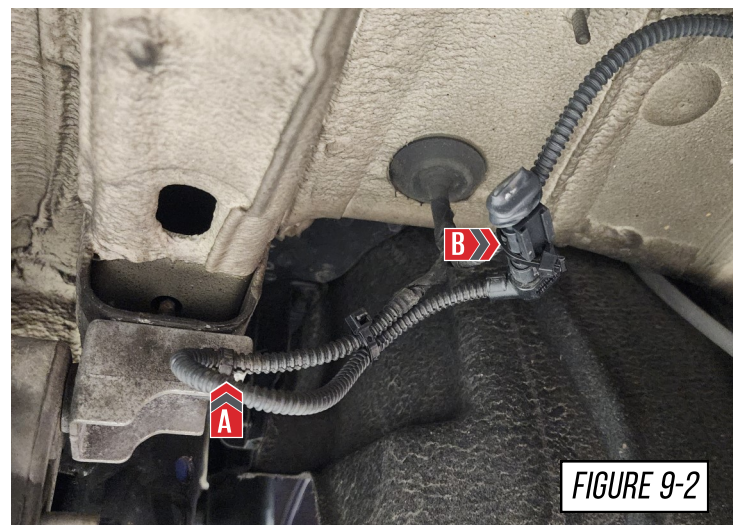
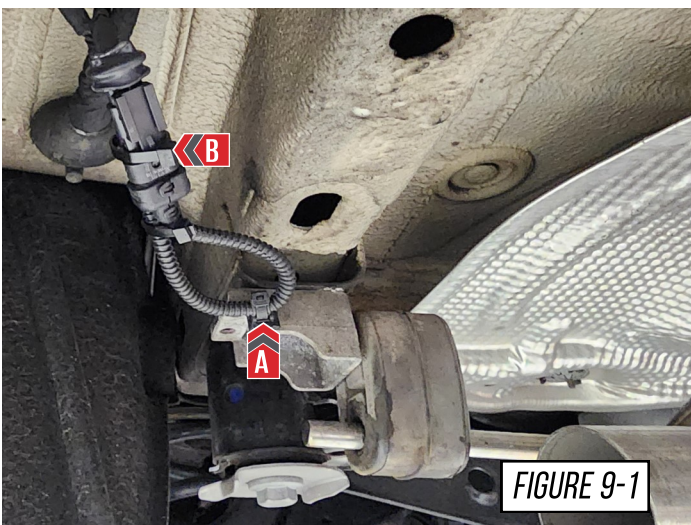

STEP 10

To install the exhaust tips with integrated clamps, first, attach the exhaust tip in the proper orientation onto the exhaust outlet tube.

Insert one of the carriage bolts from the hardware kit (**3910-41010**) through the tab on the exhaust tip and thread on one of the corresponding nuts.

Using anti-seize on the bolt threads will help installation and prevent breakage of hardware.

 If exhaust system only has 2 exhaust tips while the integrated clamp kit has enough hardware for our 4 tip exhaust systems. You will have 2 sets of hardware left over that will not be used.

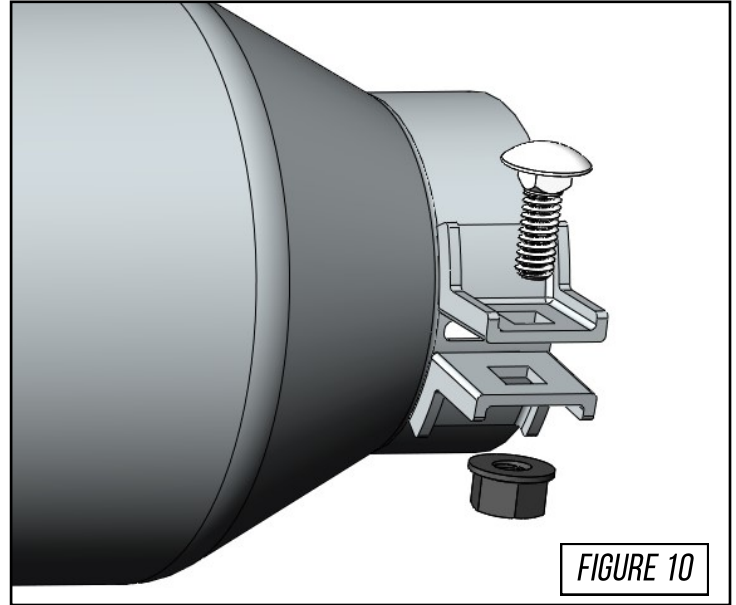

STEP 11

Now install your four tips onto your exhaust, as shown in **Figure 11**.

With you're your tips installed, work from front clamps back fully tightening all clamps, and bolts. Ensure the tips stay in their desired position.



STEP 12

For the rear sections, hanger bar collar clamps are provided to prevent side to side movement of the exhaust system. After sliding the exhaust hanger bar through the OEM grommet, install the collar clamp on the outside end of the bar as shown in **Figure 12**.

The driver side lock collar will be installed as shown in **Figure 12-1**.

The passenger side lock collar will be installed as shown in **Figure 12-2**.

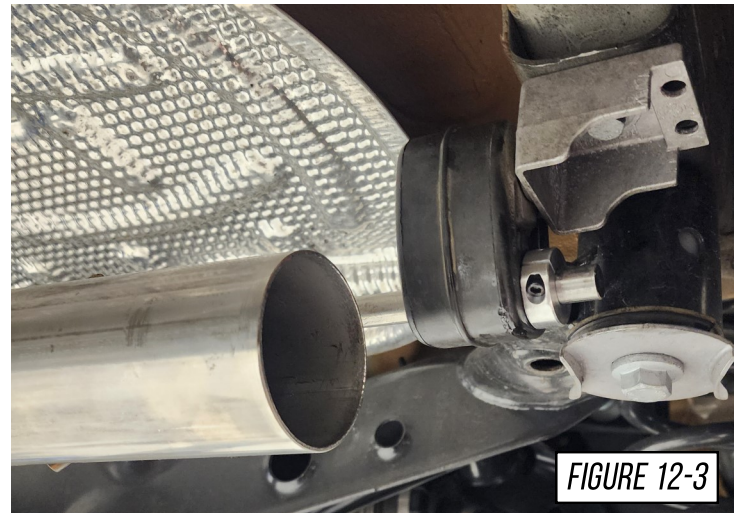
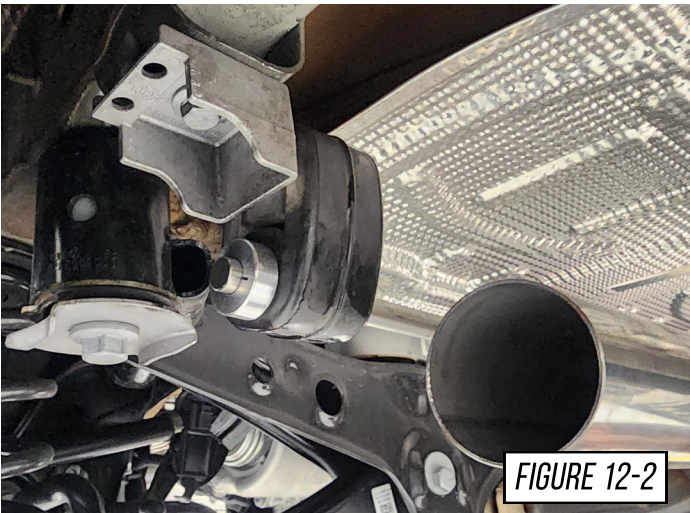
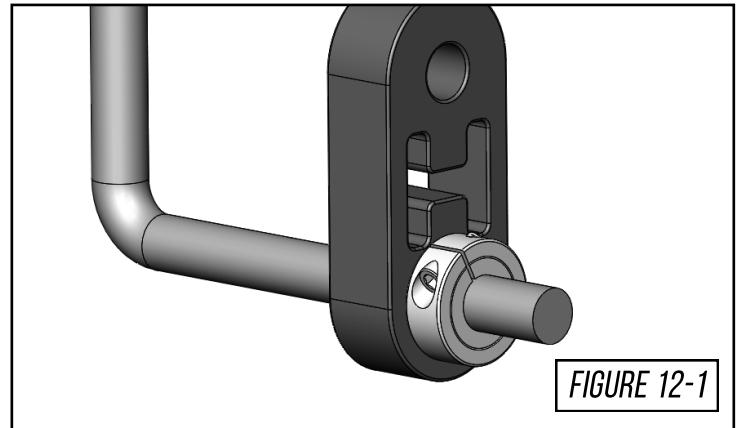

STEP 13

With the complete AWE exhaust system installed, all clamps tightened and the tips aligned. It is now recommended to drive the car to allow the exhaust to heat cycle.

 At this point the exhaust will be **very hot**, allow to cool before work continues.

With the car cooled down, check the tips for correct alignment.

 Don't forget to look below for any troubleshooting needs!



ENJOY!



TROUBLESHOOTING

Issue	Solution
Exhaust is not fitting correctly	Most fitment issues are due to improperly adjusted exhaust. This includes tip fitments and rattling due to chassis contact. Check out our FAQ/ fitment guide for more installation tips.
Incorrect or missing parts	Double check the parts list for your system and compare them with what you received. Fill out our contact form, found below and let us know what parts you need.

CARE

Once installed properly, your AWE exhaust will provide years of trouble-free performance.

The exhaust volume and sound will settle with usage; 800-1000 miles is required to break-in new exhaust systems.

Also, please note that the rear **180Technology**® resonator has a small drain hole to allow condensation to escape. Water drops from this area are normal.

Periodic cleaning of exhaust tips is necessary to maintain proper finish, especially in areas prone to road salt and caustic deicing solutions. Use a mild soap and water solution or car wax to clean the finish. Avoid using abrasive polishes, as they can scratch the finish. For best results, we recommend [AWE's Fantastic Tip Tonic](#).

Any questions or comments,
please do not hesitate to contact us:

AWE
[CONTACT FORM](#)

WARRANTY

Up-to-date warranty information is found [HERE](#).