

PERRIN

Air Oil Separator for 02-07 WRX/STI Top Mounted Intercooler Setups

2023-10-05

PSP-ENG-605

Thank you for purchasing this PERRIN product for your car! Installation of this product should only be performed by persons experienced with installation of aftermarket performance parts and proper operation of high performance vehicles. If vehicle needs to be raised off the ground for installation, the installer must use proper jacks, jack-stands and/or a professional vehicle hoist for safety of the installer and to protect property. If the vehicle is lifted improperly, serious injury or death may occur! Please read through all instructions before performing any portion of installation. Always use appropriate personal protection equipment such as gloves, eye and hearing protection for installation of this product. If you have any questions, please contact our tech department prior to starting installation. We can be reached in any of the following methods:

Email Tech@PERRINperformance.com

Instant Chat off the main page of www.PERRINperformance.com

Or simply call our tech team at 503-693-1702



WARNING: This product can expose you to chemicals including Lead which is known to the State of California to cause cancer birth defects or other reproductive harm. For more information, go to www.P65Warnings.ca.gov

GENERAL MODIFICATION NOTE

Modifications to any vehicle can change the handling and performance. As with any vehicle extreme care must be used to prevent loss of control or roll-over during sharp turns or abrupt maneuvers. Always wear seat belts, and drive safely, recognizing that reduced speeds and specialized driving techniques may be required. Failure to drive a vehicle safely may result in serious injury or death. Do not drive a vehicle unless you are familiar with its unique handling characteristics and are confident of your ability to maintain control under all driving conditions. Some modifications (and combinations of modifications) are not recommended and may not be permitted in your state or country. Consult the owner's manual, service manual, instructions accompanying these products, and local laws before purchasing and installing these modifications. You are responsible for the legality and safety of the vehicle you modify using these components.

SPECIAL NOTES:

- Installation of this part should be performed by a qualified technician as this is a complicated and time-consuming installation with many different steps and optional hook ups along the way.
- Read through entire installation before starting this project. There is a decent amount of planning needed for hose routing, and it is important to understand the full installation before beginning installation of the AOS.
- **The included foam filter/diffuser is not recommended to be used in climates that drop below freezing temps. Normal water vapor that travels through the engine can collect on this and freeze, causing a restriction in flow through the AOS. The AOS will function perfectly fine with this piece removed. This diffuser is recommended for race cars that can see excessive oil sloshing into the heads during high "G" cornering, as this helps diffuse any massive amounts of oil that could reach the AOS.**
- We have provided a couple of methods on how to hook this up to your engine. Keep in mind there are many variations of how this can be installed. Consult your tuner or qualified technician before installing this part on your car to better determine how it should be setup on your vehicle.
- The PERRIN Air Oil Separator (AOS) was designed to remove a significant amount of the oil and water vapor that normally gets sent to your intake system to be ingested by your engine. There are many variables as to how much oil will make it past our AOS, but expect it to remove a significant amount of the crank case blow by. For cars with built engines with excessive blow-by, you may still experience oil getting past our Air Oil Separator.

NPT Notes:

- There are many NPT (National Pipe Thread) fittings included with your Air Oil Separator. Throughout the instructions, these notes below will be referred to, and it's important to understand these types of fittings and how they work.
- NPT fittings are a tapered thread that seals when tightened, not bottomed out. Thread fittings in by hand and tighten roughly 1/2 to 1 full turn more until fitting is tight. **NOTE: Using a small amount of Teflon tape on threads is a good idea to ensure a proper seal. Teflon tape is rated to work up to 500F and is impervious to all chemicals that your AOS will see. This is highly recommended to use over any other sealant.**
- Angle of 90 degree fittings can be adjusted after tightening, as long as they are not backed off more than 1/4 of a turn.

Included Parts with PERRIN Air Oil Separator for Top Mount Intercoolers:

- (1) PERRIN Universal Air Oil Separator (AOS)
- (1) O-rings
- (1) 02-07 or 08-13 TMIC AOS Bracket
- (1) Crank Case Vent Adapter
- (9') 1/2" Crank Case Vent Hose
- (1.625") 3/4" Crank Case Vent Hose
- (3') 3/8" Fuel Injection Hose
- (5') 5/16" Coolant Hose
- (4') 5/16" Fuel Injection Hose
- (9) #3 Hose Clamps
- (4) #2 Hose Clamps

- (2) #27mm Hose Clamp
- (1) 1/2" Vacuum Cap
- (2) 3/8 NPT 1/2" Straight Fitting
- (2) 3/8 NPT 1/2" 90 Degree Fitting
- (1) 1/4 NPT 3/8" Barb Straight Fitting
- (1) 3/8 NPT- 1/2" Barb Female Fitting
- (2) 1/4 NPT 1/2" Barb Straight Fitting
- (2) 1/8 NPT 5/16" 90 Degree Barb Fitting
- (1) 1/8NPT 5/16" 90 Degree Barb Fitting
- (2) 1/8 NPT 5/16" Straight Barb Fitting
- (2) 1/2" Y Connector
- (1) 1/2" Tee Connector
- (2) 1/2"-1/2" Connector
- (1) 5/16"-5/16" Connector
- (3) 3/8 NPT Plug
- (2) 1/4 NPT Plug
- (1) M10x80mm Hex Bolt
- (1) M10 Nut
- (8) 3/8" Washers
- (3) M8x16mm Button Head Cap Screw
- (3) M8 SS Washers
- (2) M6x14mm Button Head Cap Screw
- (2) M6 SS Washer
- (1) M4 Hex Wrench
- (1) M5 Hex Wrench
- (1) M6 Hex Wrench
- (20) Zip Ties



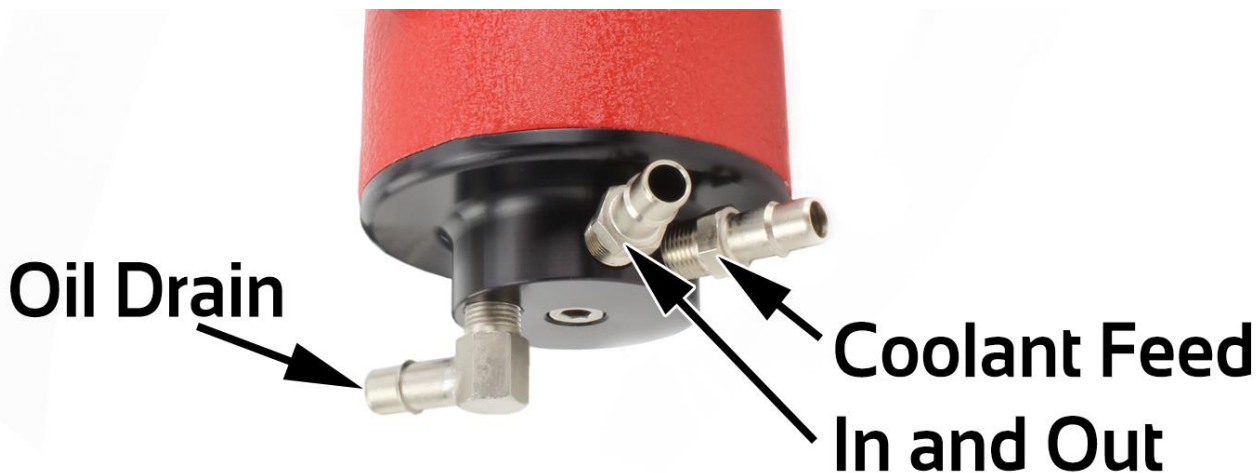

Installation Instructions

1. Using the above diagram as a guide, take note of all fittings and our recommended connections. There are many options and many ways to install this. Please read through all instructions before proceeding with install.
2. Locate and remove intercooler (including Y-pipe and throttle body coupler) from engine or any boost tubes connected to turbo and throttle body. This is necessary to gain access to center crank case vent, PCV system and other items.

3. Assembly and Orientation

- a. Each AOS is pre-assembled with M6 bolt, nylon seal, O-ring and foam filter inside for packaging purposes. To ensure your AOS has an oil tight seal, ensure that bolt is hand tightened before finishing steps below. Failure to tighten M6 bolt will lead to vacuum leaks and oil leaking out bottom of can.
- b. See above note regarding the use of the foam filter/diffuser in your AOS.
- c. Orientate bottom to desired position (based on steps below) and hand tighten bolt until bottom is mostly flush with AOS body. This may need to be done a couple times throughout the installation. **NOTE: A slight mismatch can occur if bottom is pushed to one side or to the other. Make sure bottom is centered over body while tightening, or an oil leak can occur.**

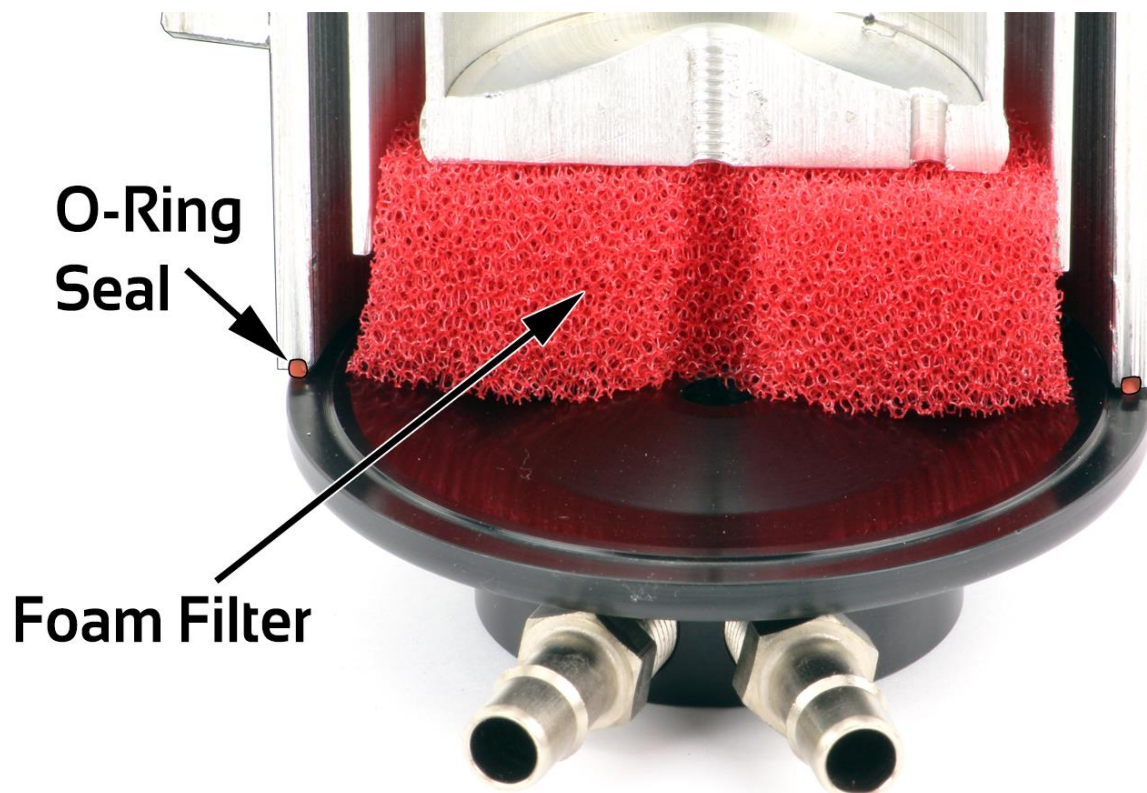

Cutaway Showing Internals of AOS

- d. If bottom is removed, or bolt is loosened too far, the o-ring may become dislodged. Ensure that o-ring is all the way around groove in bottom of AOS body before tightening bolt into bottom of AOS. **NOTE: Some powder coating will be in the groove and this is ok as the o-ring will seal**

once tightened.

4. Mounting of AOS to Chassis

- a. The placement of the AOS needs to meet two main criteria. First, the oil drain port needs to be higher than the engine port used for draining oil back into the engine. As long as this is mounted higher, AOS will drain properly. Secondly, AOS also needs to be mounted vertically like in above picture. It will not function properly if mounted on its side or at an angle.
- b. The supplied bracket is designed to allow AOS to fit on a car with Top Mount Intercooler installed. This puts the AOS in the proper location for it to clear turbos, intercoolers and other commonly installed parts. Before proceeding to Step 4, test fit AOS in this location to ensure it clears boost tubes and any other components that might be installed.



- c. Locate (2) M6 threaded holes in right side shock tower. These will be used to mount the AOS bracket. These are located in the same place on every chassis, but will be covered up by different things depending on the year. 02-05 WRX will need to remove and disable the cruise control actuator. 06 WRX and STI need to remove small plastic plugs or stickers covering holes. 2007-14 WRX and 07-21 STI need to remove a bracket holding the engines wire harness plug to the chassis. **NOTE: None of these items will be reinstalled. In later step, you will need to secure wire harness and plug away from turbo.**
- d. Install supplied mounting bracket to AOS body using supplied M8 button head screws and SS washers. Slide AOS to the upper side of the slot to start with and tighten down.



- e. With AOS mounted to bracket, secure bracket to shock tower using supplied M6 bolts and SS washers. **NOTE: Below picture shows bracket**

mounted to chassis without AOS bolted to it. This is done to clearly show how bracket is mounted to shock tower.



- f. Make sure AOS clears all OEM hoses, lines and other things in engine bay.
- g. Temporarily adjust AOS bottom and its rotation. Loosen bolt in bottom of AOS and adjust rotation of bottom so that threaded holes are accessible. Further adjustments may need to be made in future steps.
- h. Over the next few steps it may be necessary to remove AOS from bracket to adjust orientation of bottom and fittings to better match your specific setup. It is not necessary to tighten bracket fully until final step.

5. Coolant Feed Connections

- a. The coolant connection is an optional hookup, but we **HIGHLY** recommend connecting these up as they help reduce water vapor and sludge that can build up in AOS. The easiest connection to get coolant from is the throttle body, as all Subaru models have the same coolant connections on the throttle body that can be used. Other connection points can be used as long as there is some coolant flow through the hoses. **NOTE: Installing coolant connection will cause some coolant loss and coolant spill. Make sure to top off coolant after installation is complete.**

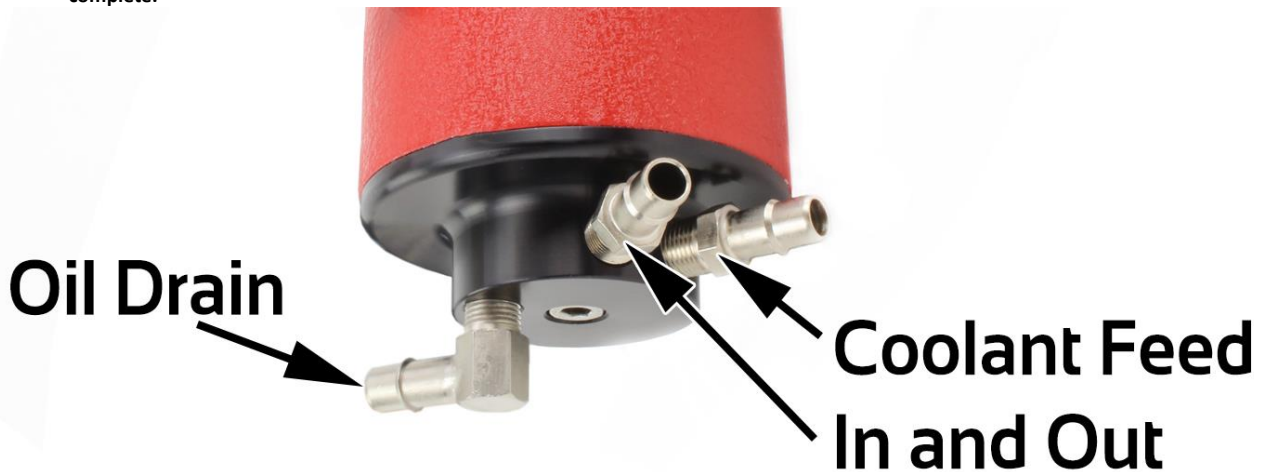

- b. Install supplied 5/16" fittings into coolant ports on the side of AOS bottom as shown above. This fitting is NPT, which is a tapered, thread that seals when tightened, not bottomed out. Thread fittings in by hand and tighten roughly 1/2 to 1 full turn more until fitting is tight. **NOTE: Using a small amount of Teflon tape on threads is a good idea to ensure a proper seal.**

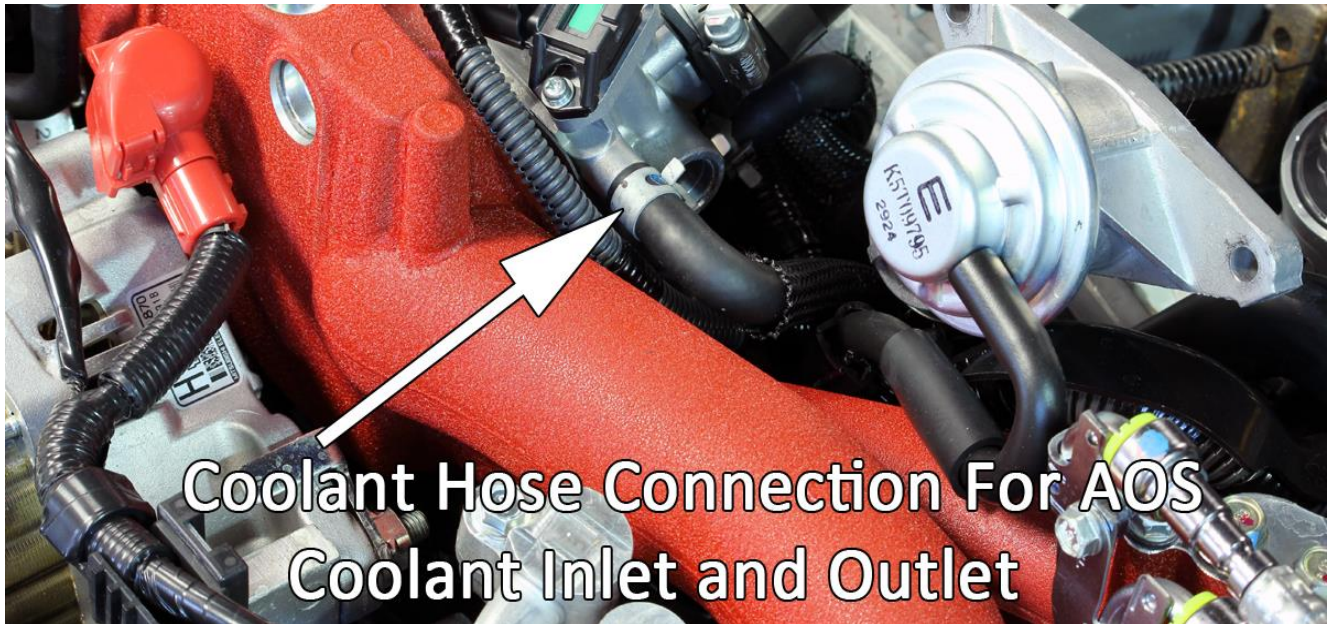

Picture above shows 04+STI throttle body. 02-05 WRX throttle body will appear slightly different.

- c. Locate coolant hose on throttle body (shown above) that will be used to supply coolant to AOS bottom.
- d. Disconnect coolant hose from throttle body and install supplied 5/16"-5/16" adapter into hose. Secure with OEM pinch clamp.
- e. Install supplied 5/16" coolant hose to 5/16" adapter and route hose to either coolant feed fitting on AOS bottom. Cut hose to length, install onto fitting and secure both ends using supplied #2 hose clamp. **NOTE: During this step it is important to orient AOS bottom so coolant feed hoses, have the cleanest path to engine. Expect to orient bottom at least one more time before installation is complete.**

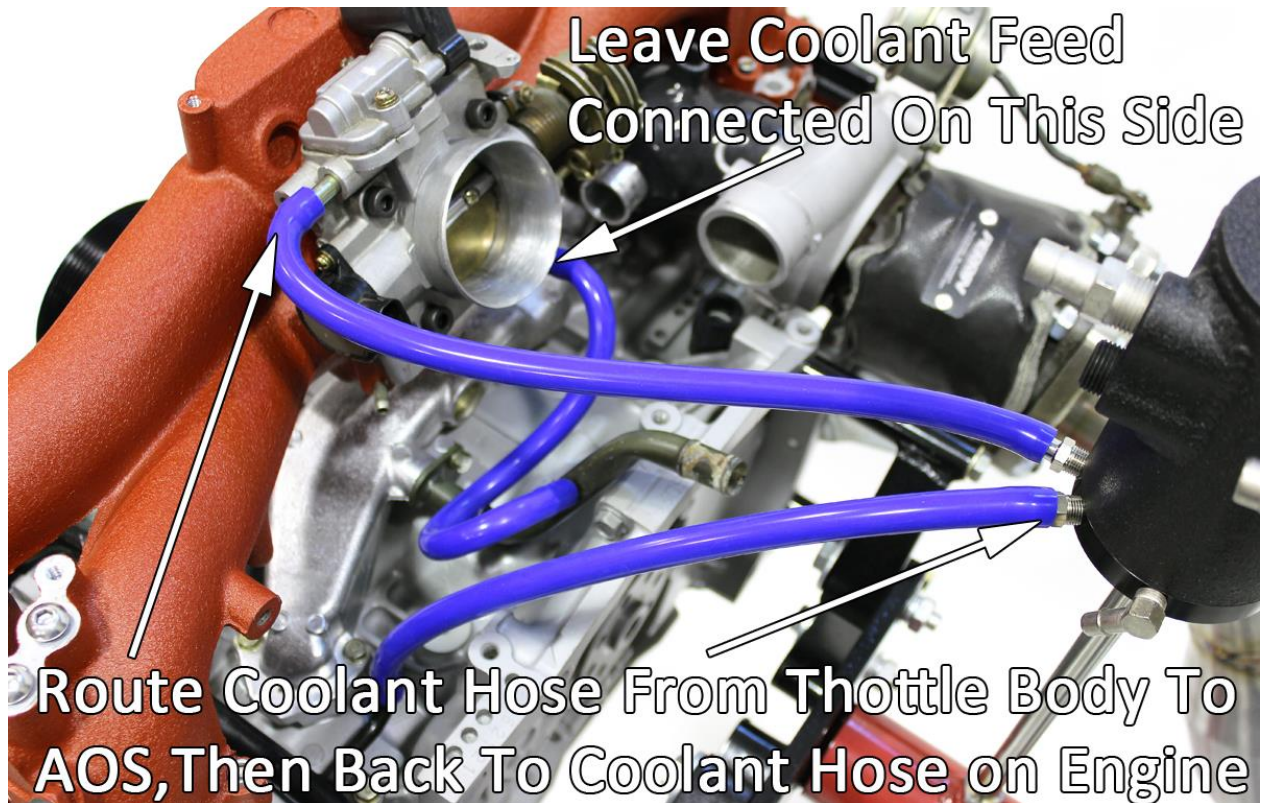

Actual routing of hoses may not be represented above. Diagram shows simplified path to help visualize routing.

- f. Install remaining 5/16" coolant hose to 5/16" fitting on AOS bottom and secure with supplied #2 clamp. Route hose back to fitting left open on throttle body and secure with supplied #2 hose clamp. **NOTE: Orient AOS bottom again, to ensure the cleanest path to engine. Expect to orient bottom at least one more time before installation is complete.**
- g. Using above diagram, you can visualize the coolant hose connections for all cars. This diagram has been simplified to show the hose routing. Hoses can be routed differently depending on where the AOS is mounted or if intercooler plumbing requires this. Keep in mind that the coolant fittings on the AOS become part of the coolant path from engine to throttle body.

6. Oil Drain and Crank Case Vent Connection

- a. The AOS oil drain is **NOT** an optional hook-up as the AOS is not designed to contain oil within itself. This fitting is used to drain the oil that is captured within the AOS body back to the engine through a crank case vent.

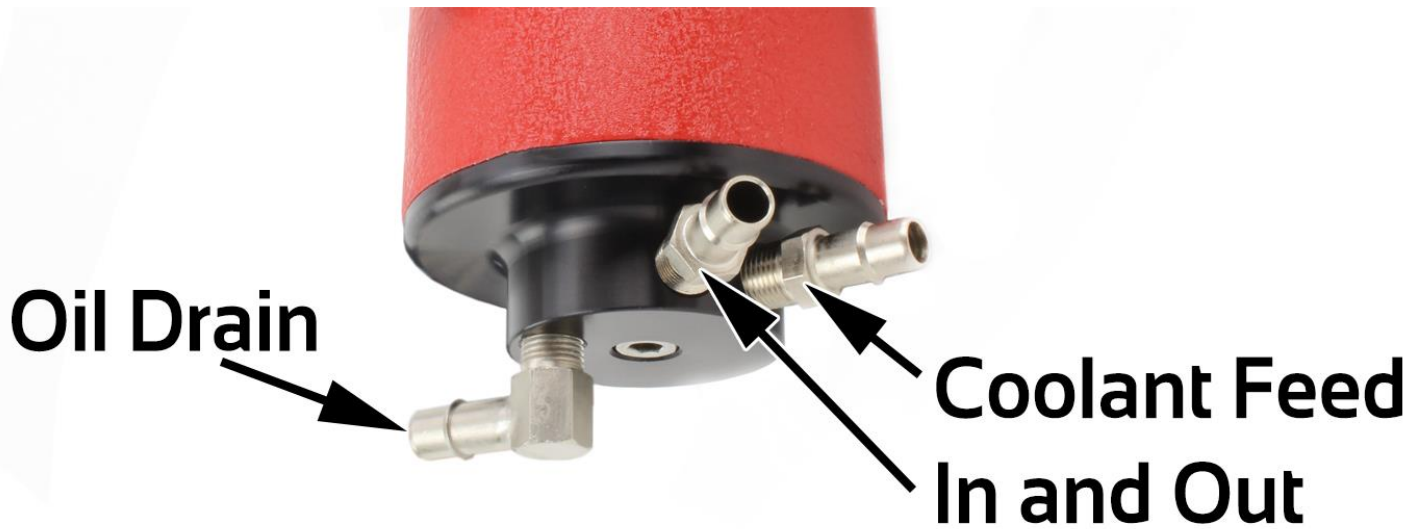

- b. Install supplied 5/16" 90 degree fitting into oil drain outlet (shown in diagram above) in bottom of AOS keeping in mind that this needs to point in the direction the drain hose will be routed. See NPT Notes above regarding installation of this fitting.

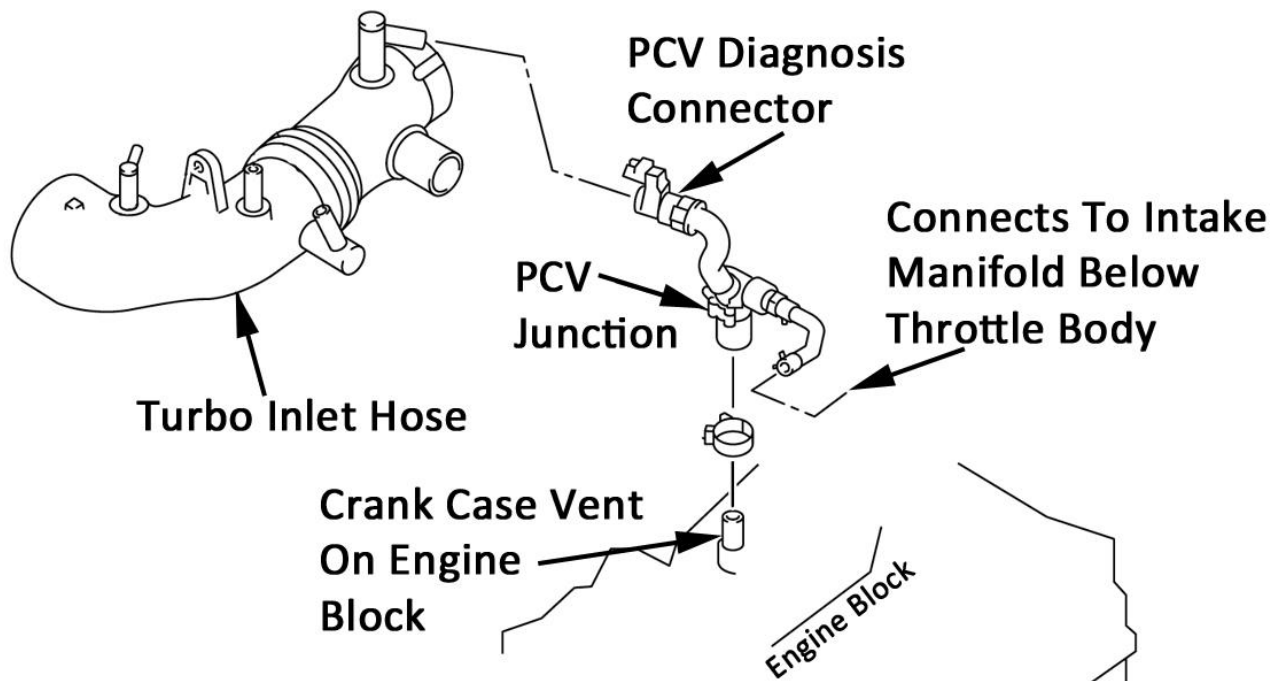

Picture above shows typical 2002-07 WRX, and 2004+ STI PCV Junction. (2002-2003 WRX does not have PCV diagnosis connector)

- c. Locate and remove throttle body from intake manifold for better access to crank case vent and PCV connection (shown in picture below).
- d. Using diagrams above and below, locate PCV junction and remove from 3 connections, crank case vent, intake manifold and PCV diagnosis connector (some cars do not have a PCV diagnosis connector but rather a fitting on the turbo inlet hose). Take note of intake manifold connection, as you need to connect a fitting or hose (depending on application) to this in a later step. **NOTE: When removing PCV Junction on 2004+ STI and 2005+ WRX models, leave PCV diagnosis connector electrically connected and only remove hose from PCV diagnosis connector.**

Remove Rubber
Hose Leaving
Diagnosis
Connector
In Place

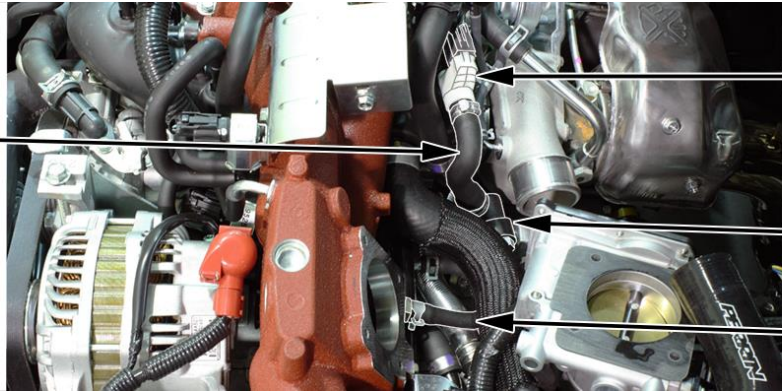

PCV Diagnosis
Connector
PCV Junction On
Engine Block
PCV Hose

Above picture shows STI with PCV junction exposed.

- e. Using supplied 1/2" vacuum cap, plug open connection on PCV diagnosis connector (or turbo inlet hose fitting). **NOTE: It is important to ensure there are no vacuum leaks in turbo inlet hose after this step is complete. This will cause a lean condition and lead to engine damage.**
- f. Check OEM crank case vent junction to see if short rubber hose (3/4" ID x 2" long) was pulled off crank case vent in above step. If so, remove from OEM PCV junction and reinstall to engine block as this is used to connect PERRIN crank case vent adapter to engine block.
- g. With short rubber hose on block, remove upper pinch clamp from hose and loosely install supplied 27mm clamp.
- h. Using diagram below as a guide, install supplied 5/16" 90 degree fitting into PERRIN crank case vent adapter making sure to aim in the direction shown below or in a direction that allows oil to travel downhill from AOS bottom. **See NPT Notes above regarding installation of this fitting.**

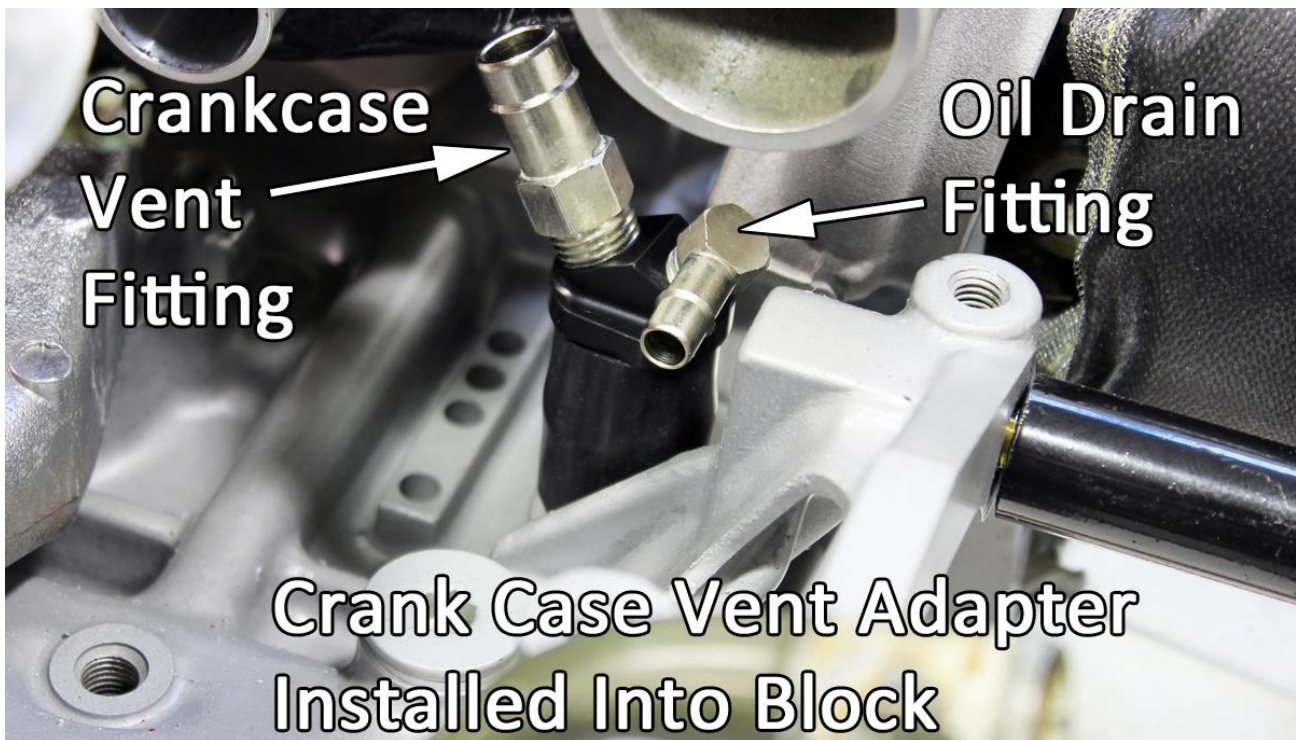

Direction of fitting shown that works for most installations. Fitting can be rotated in any other direction as long as oil draining from the AOS can maintain a downhill path to fitting.

- i. Using diagram above, install supplied 1/2" straight fitting into PERRIN crank case vent adapter. **See NPT Notes above regarding installation of this fitting.**
- j. Install PERRIN crank case adapter into supplied 3/4" hose on engine crank case vent and secure using supplied 27mm hose clamp.

Crank Case Vent Junction

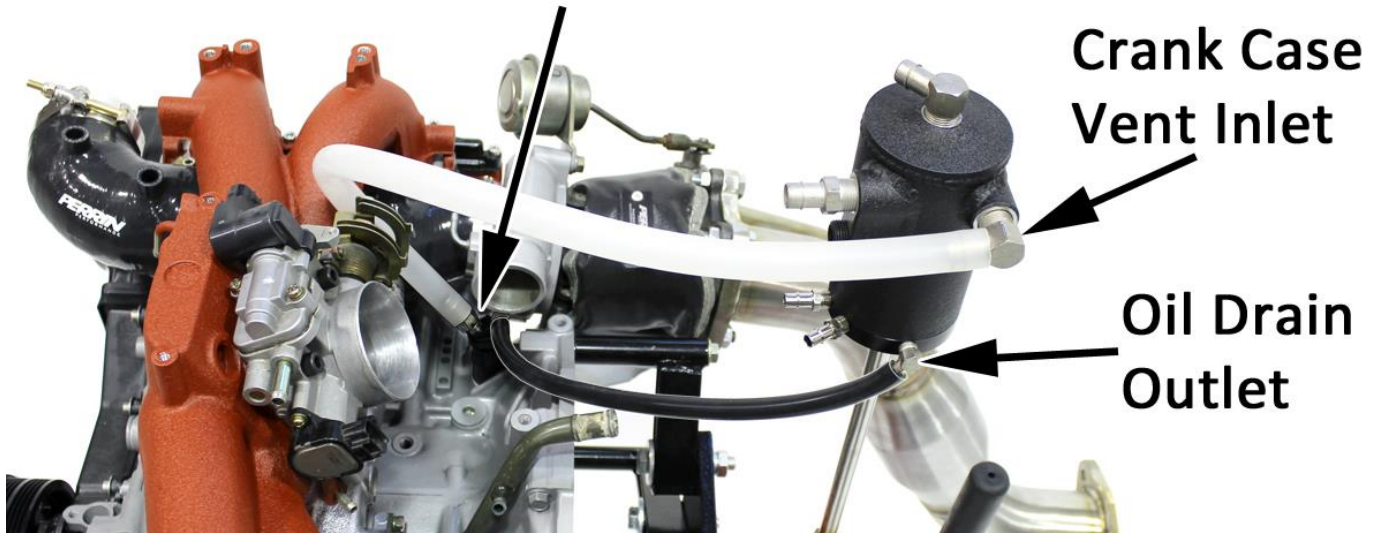

Actual routing of hoses may not be represented above. Diagram shows simplified path to help visualize routing.

- k. Using diagram above and supplied 5/16" fuel injection hose, connect oil drain outlet on the bottom of AOS to 5/16" 90-degree fitting on PERRIN crank case vent junction. Secure both ends using supplied #2 Hose clamps. **NOTE: It is very important to route this hose such that it NEVER travels uphill from bottom of AOS to crank case vent fitting. Also during this step, it is important to orient bottom so drain and the next step of installing coolant feed, has the cleanest path to engine.**
- l. Install supplied 1/2" 90-degree fitting into crank case vent inlet, on side of AOS body. **See NPT Notes above regarding installation of this fitting.**
- m. Using diagram above and supplied 1/2" Emissions Hose, connect 1/2" fitting on PERRIN crank case vent junction to 1/2" fitting on side of AOS. The direction of this fitting is not critical and can be adjusted to fit your installation. Use supplied clamps to secure both ends. **NOTE: Routing of this vent hose is not that important, just makes sure it is not pinched off while traveling to AOS body.**
- n. For cars that see an extreme amount of high G's or an excessive amount of blow by, we recommend a slightly different installation for the crank case vent hoses. See special notes below for this.

7. Valve Cover Vent Inlet Connections

Your Subaru engine has a valve cover vent on both left and right heads that need to be routed to the AOS. The method for doing this can vary depending on the desired setup. Read through all 3 options below before deciding which is best for your setup.

- a. Most all models will appear to have two vents on each valve cover and two crank case vents (except 2002-05 WRX only has 1 of each), only one set of these are considered vents, the other set we consider balance vents. These balance vents connect both valve covers to center crank case vent together with piping and hoses, and are to be left alone. Using diagram below, locate valve cover vents that toward the front of the engine, and connect to piping on intercooler.

Do Not Use Rear Crankcase Balance Vents

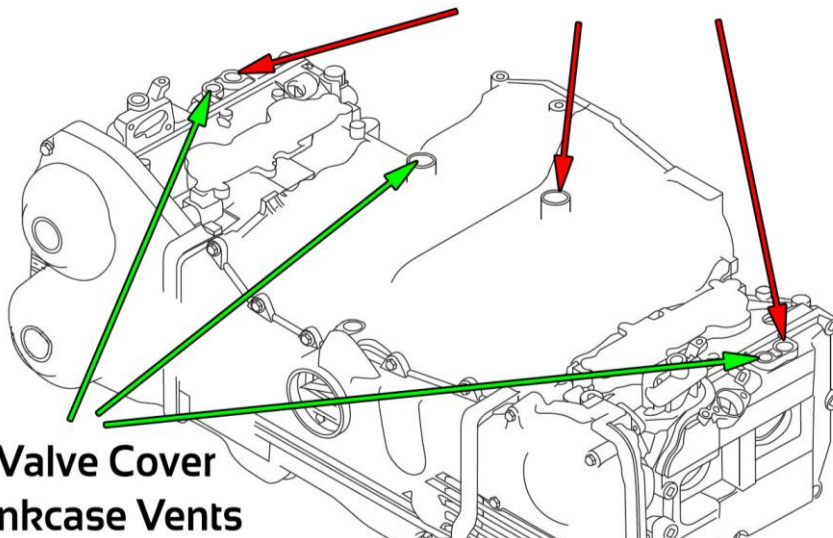

Correct Valve Cover and Crankcase Vents

- b. Once proper set of valve cover vents are located, decide if you want to:

- i. Use OEM piping on top mounted intercooler as the "T" connection, and use only one of the two AOS valve cover inlet ports. This is the simplest and cleanest method (Shown below in picture of AOS in engine bay). Continue to Step "c" below.
 - ii. Join both valve cover vents using supplied "T" or "Y" connector, replacing all OEM hoses with supplied 1/2" emissions hose and using only one valve cover vent inlet port on AOS. This method is preferred if OEM hoses are old and hard, or aftermarket parts may be installed affecting installation. (Shown below in picture of AOS on engine stand). Continue to Step "e" below.
 - iii. Connect each valve cover vent separately to each of the AOS valve cover vent inlet ports. This method is what we recommend to provide the best venting while under high lateral G forces. If connecting each vent separately, skip to step "h".
- c. If you are using the OEM piping on top mounted intercooler as your "T" connection, install (1) supplied 1/2" barbed 3/8NPT straight fitting into one of the AOS valve cover vent inlets. Install supplied 3/8NPT plug into remaining valve cover vent inlet. **See NPT Notes above regarding installation of these fittings.**
- d. Remove OEM rubber hose from piping on intercooler connecting to turbo inlet hose. Using supplied 1/2" emissions hose connect pipe on intercooler to 1/2" fitting installed on AOS valve cover vent inlet port. See diagram below showing piping or "T" Junction on intercooler and hose connecting it to the AOS. Continue to Step 8.

Remove Hose From Piping Here

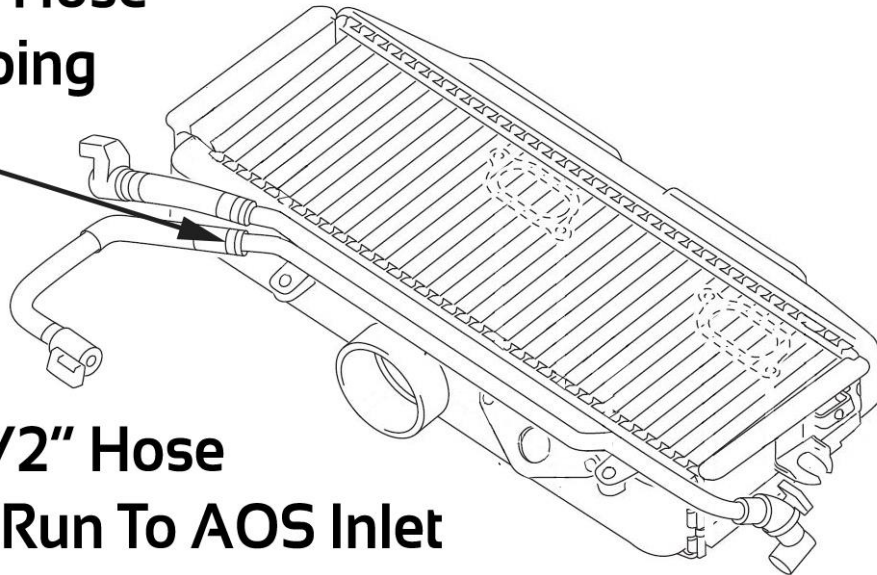

Connect 1/2" Hose To Piping, Run To AOS Inlet

1. Using supplied plastic connectors and 1/2" emissions hose, connect crank case vent hoses together. See picture above showing routing of hose and fittings. This will vary slightly from 2008-17 models versus 2018+ models.
 - a. For models with pinch type clamps.
 - i. Install Tee fitting on right side of engine (joining two OEM hoses together).
 - ii. Install straight fitting into OEM hose on left side.
 - iii. Install supplied 1/2" emissions hose to Tee fitting, and route hose down between throttle body and turbo then across to straight fitting as shown in picture. **NOTE: Extra connectors are supplied for different setups and you may not use all of them.**
 - b. Models (2018+) with seamless band clamps and PCV diagnosis connectors.
 - i. Using a Dremel or small cutoff wheel, cut clamps very carefully where they are clamped onto the OEM steel crank case piping. Cut each clamp at an angle and most of the way through. Try not to generate too much heat of the hose will start to melt and damage the hose. Take light cuts until your tool just starts to break through the clamp. See picture below for reference.

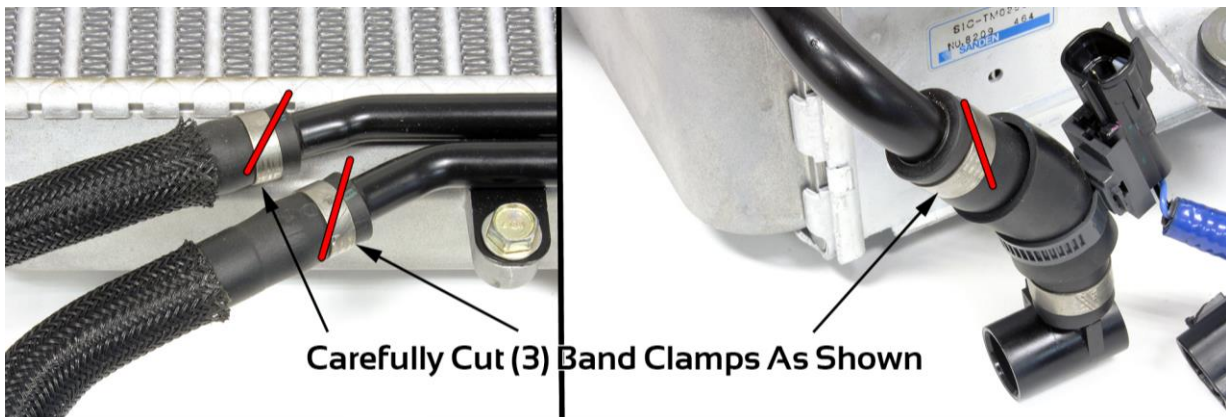

Carefully Cut (3) Band Clamps As Shown

- ii. Using a flat head screwdriver or pliers, twist clamp apart and remove from hose.
- iii. Remove hoses and fittings from steel crank case piping and reconnect them (electrically and physically) to their respective locations on the engine. **NOTE: Don't forget to plug in the additional plug on right side.**
- iv. Install supplied Y fitting to both OEM hoses on right side and straight fitting into hose on left side.

- v. Install supplied 1/2" emissions hose to Y fitting, and route hose down between throttle body and turbo then across to straight fitting as shown in picture. Trim hose to best fitting length that does not create kinks in the hose. **NOTE: Extra connectors are supplied for different setups and you may not use all those supplied.**

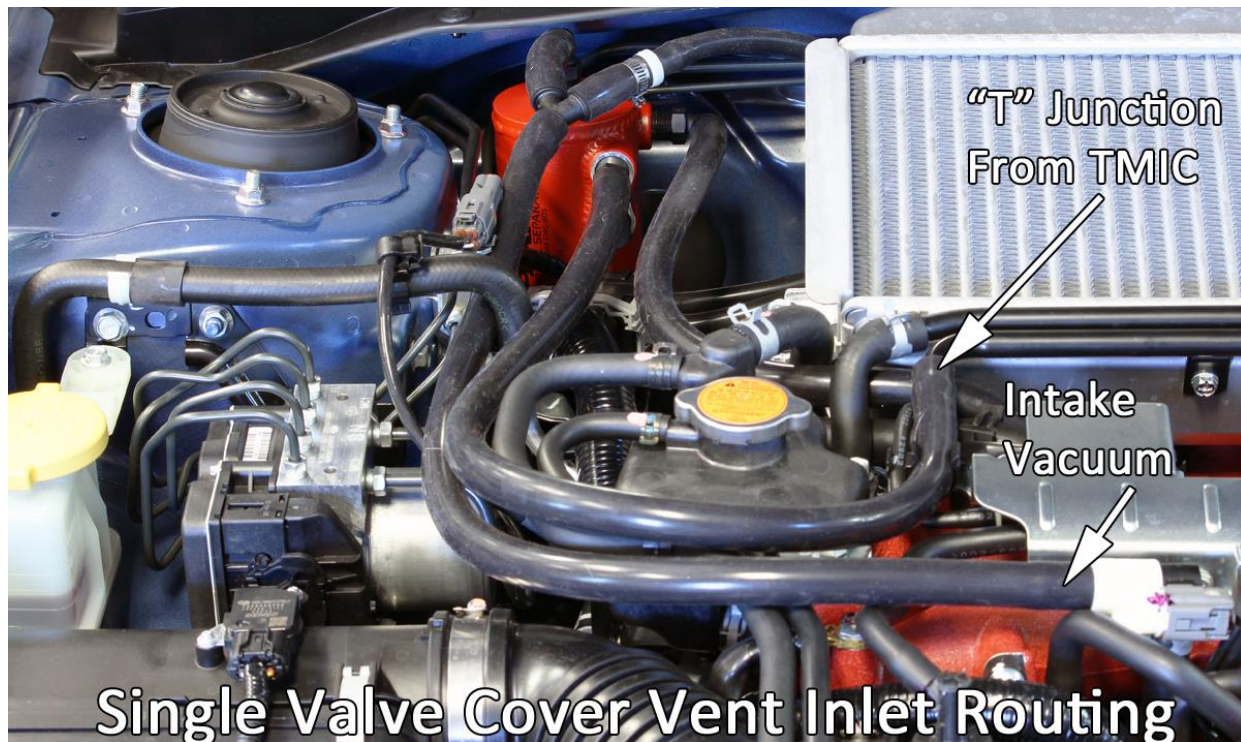

The above setup shows a simple setup that uses the OEM valve cover vent piping (bolted to the intercooler). The extra port on AOS that gets plugged, is not seen in the picture above as the hose is covering it up.

- e. If you are connecting each valve cover vent to the AOS using a supplied "Tee" or "Y" fitting, install (1) supplied 1/2" barbed 3/8NPT straight fitting into one of the AOS valve cover vent inlets. Install supplied 3/8NPT plug into remaining valve cover vent inlet. **See NPT Notes above regarding installation of this fitting.**
- f. Remove all OEM valve cover vent hoses and piping on top mounted intercooler up to turbo inlet hose.
 - i. For 2002-2016 vehicles, install supplied 1/2" emissions hose onto each valve cover vent, join left and right side with supplied "Y" or "T" connector, and secure with supplied clamps. See diagram below showing "Y" connector being used. **NOTE: We recommend removing all OEM rubber valve cover vent hoses as they become very brittle over time.**
- g. Connect third leg of "Y" or "T" to 1/2" fitting used on AOS valve cover vent inlet port. You can see in the below diagram typical routing found on the most common setups. Continue onto Step 8. **NOTE: Make sure that the routing of hoses does not interfere with moving parts or travel over extremely hot parts like a turbo or downpipe.**

Valve Cover Vent Routing Using “Y” or “T” Junction

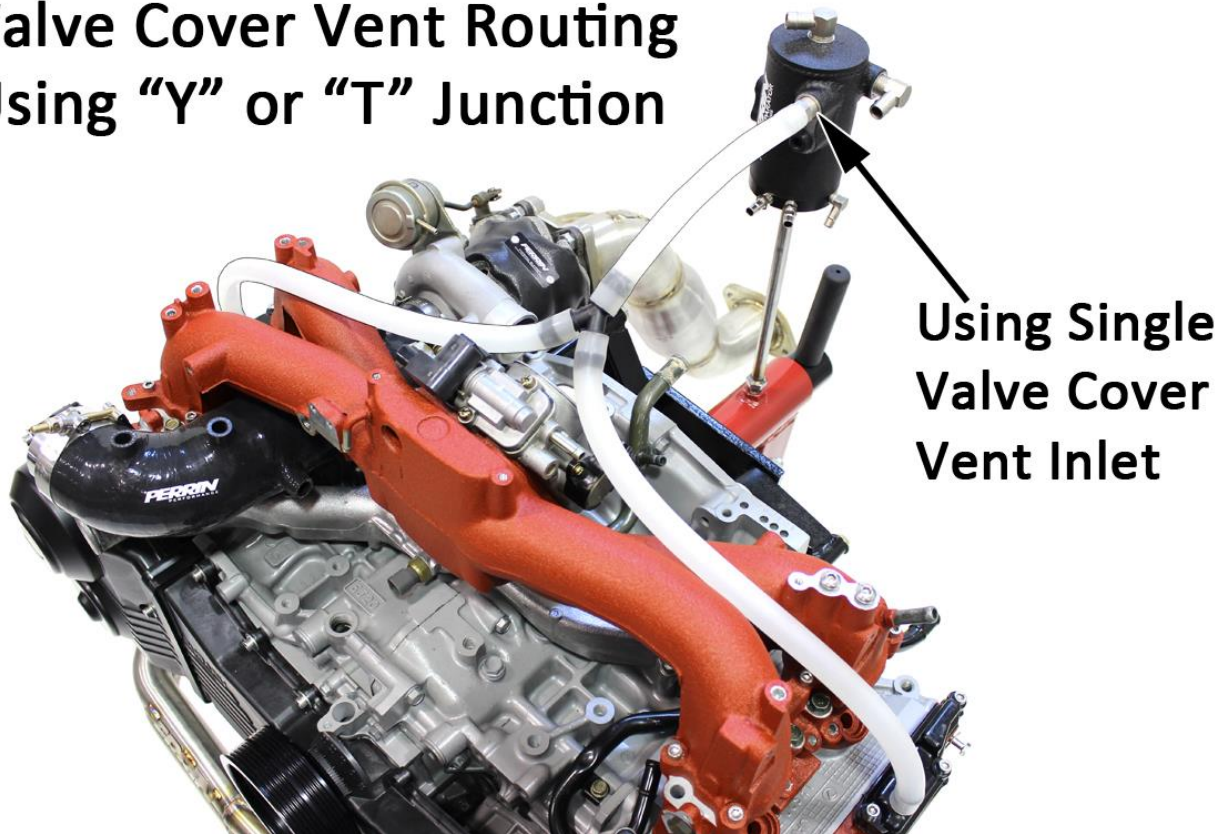

Actual routing of hoses may not be represented above. Diagram shows simplified path to help visualize routing.

- h. If you are connecting each valve cover vent separately to the AOS, install supplied 1/2" barbed 3/8NPT straight fittings into each of the valve cover vent inlet ports. **See NPT Notes above regarding installation of this fitting.**
- i. Remove all OEM rubber valve cover vent hoses and OEM steel piping on top mounted intercooler.
 - i. If installing on a 2017+ vehicle, OEM hoses from valve cover to PCV Diagnosis connectors must be left in place.
 - ii. Remove hoses between PCV diagnosis connector and intercooler piping. Use above diagram showing the 2017+ PCV diagnosis connector locations next to intercooler.
- j. Using supplied 1/2" emissions hose, connect each valve cover vent to each of the 1/2" fittings installed into the AOS valve cover vent inlet ports. Secure with supplied #3 hose clamps. **NOTE: Make sure that the routing of hoses does not interfere with moving parts or travel over extremely hot parts like turbo or downpipe.**

8. Outlet and PCV Connection

The AOS outlet is the top threaded hole on body. This connection needs to be connected to the turbo intake system in front of the turbocharger, and behind the air filter. **NOTE: We do not recommend leaving this fitting open as oil and oil vapor can still come out under certain conditions, which can create a mess or combust if exposed to extreme heat.**

There are two options to connect the AOS to your intake system. One is installing it with the PCV system functioning, and the other is removing the PCV system. The PCV is a 1-way valve that provides crank case ventilation during idle and light load situations, but it can also be a partial source of oil vapors getting into sucked into the intake manifold. For most street driven vehicles, installing the PCV valve is a good idea, but for built motors and track cars, we recommend removing this. Read through all instructions below, then read PCV Delete Instructions, before deciding how to proceed.

- a. Along this hose (connecting AOS top to intake system) we recommend installing the “Y” connection used for the PCV (positive crankcase vent). The PCV is a 1-way valve that provides crank case ventilation during idle and light load situations. This valve is important to install as described or boost pressure will be lost and there will be no positive crankcase ventilation occurring. **NOTE: The PCV connection can be skipped for certain applications, see special note below regarding this.**
- b. Locate PCV junction removed from engine block in earlier step and remove PCV valve from plastic housing as shown below. **NOTE: This can be tight to remove and may require a vise to hold housing while fitting is unscrewed. It may be necessary to use solvent or a thread penetrating oil to free from housing. 02-03 WRX's can skip this step as the OEM PCV is threaded into intake manifold and a hose will be attached directly to this in later step.**

**Remove PCV Valve from
OEM crank case fitting**

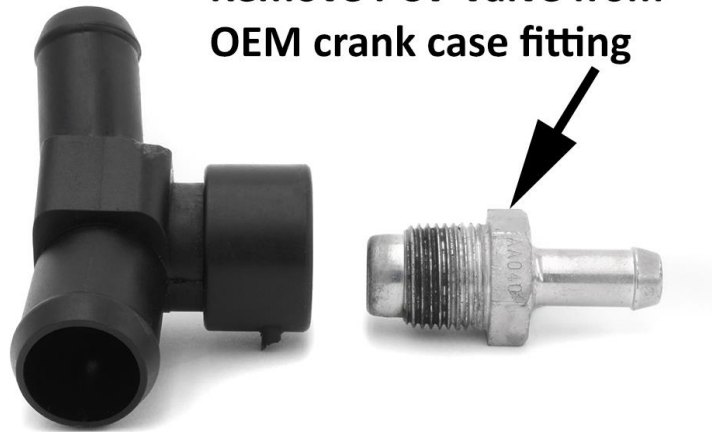

- c. Install PCV valve into supplied female fitting and tighten down. See NPT Notes above regarding installation of this fitting.

Thread OEM PCV into female barb fitting

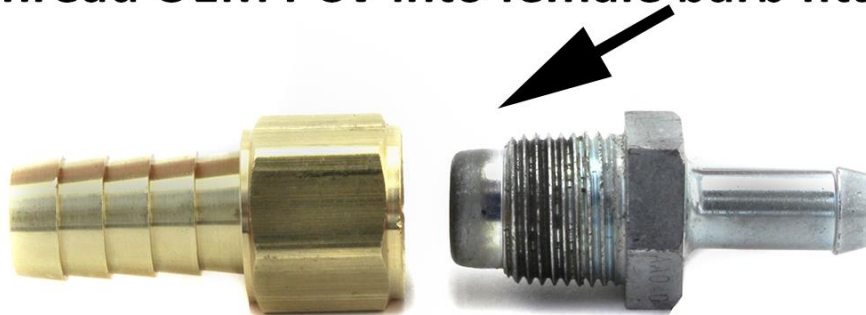

5/8 barb to 3/8NPT Fitting Shown Above May Vary In Appearance

- d. Install supplied 1/2" barb 3/8NPT 90 degree connector into top of AOS. See NPT Notes above regarding installation of this fitting.

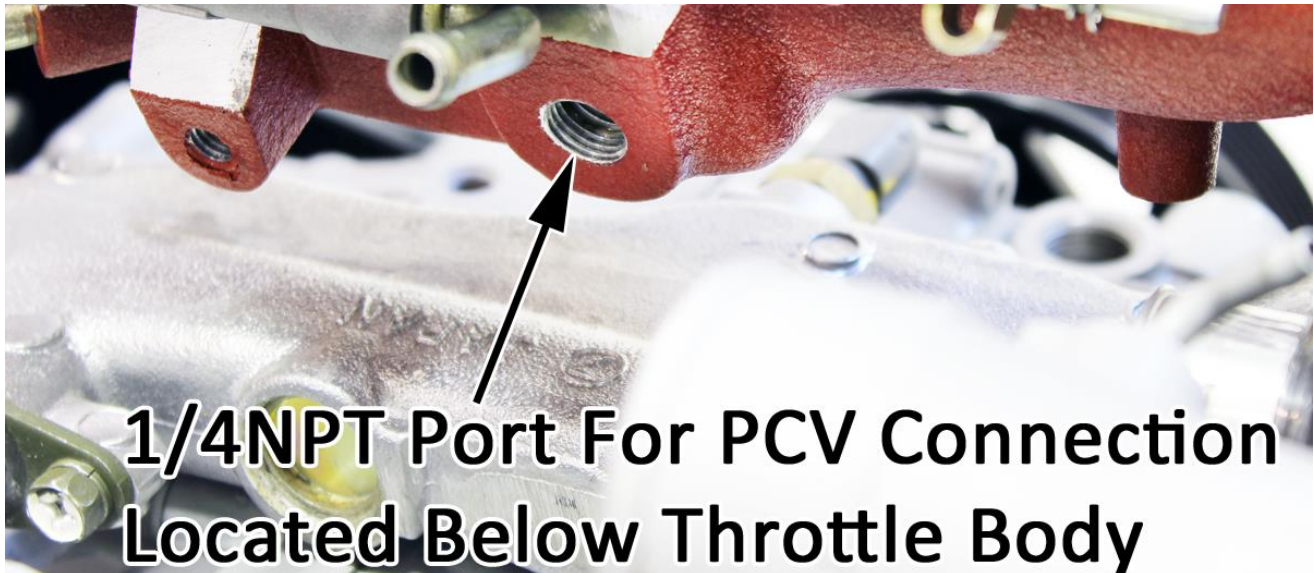

- e. Locate previous PCV vacuum connection on intake manifold under throttle body. The diagram above shows where you will find either a 3/8" fitting or PCV valve threaded into manifold. Diagram above shown
- For 2002-03 WRX's, connect supplied 1/2" emissions hose over PCV valve. This is a tight fit and will require a bit of stretching of hose as well as some force to push it over larger fitting. Use supplied #3 clamp to secure. Do not cut hose to length at this time.
 - For other models, connect supplied 3/8" fuel hose to fitting and secure with #3 clamp. Do not cut hose to length at this time.
- f. Using supplied 1/2" emissions hose, connect AOS outlet (top fitting) to intake vacuum source at turbo inlet hose.
- For 2002-11 models, cut OEM rubber vacuum hose after bends. Use supplied 1/2"-1/2" connector to join OEM rubber hose to 1/2" emissions hose. See diagram below.

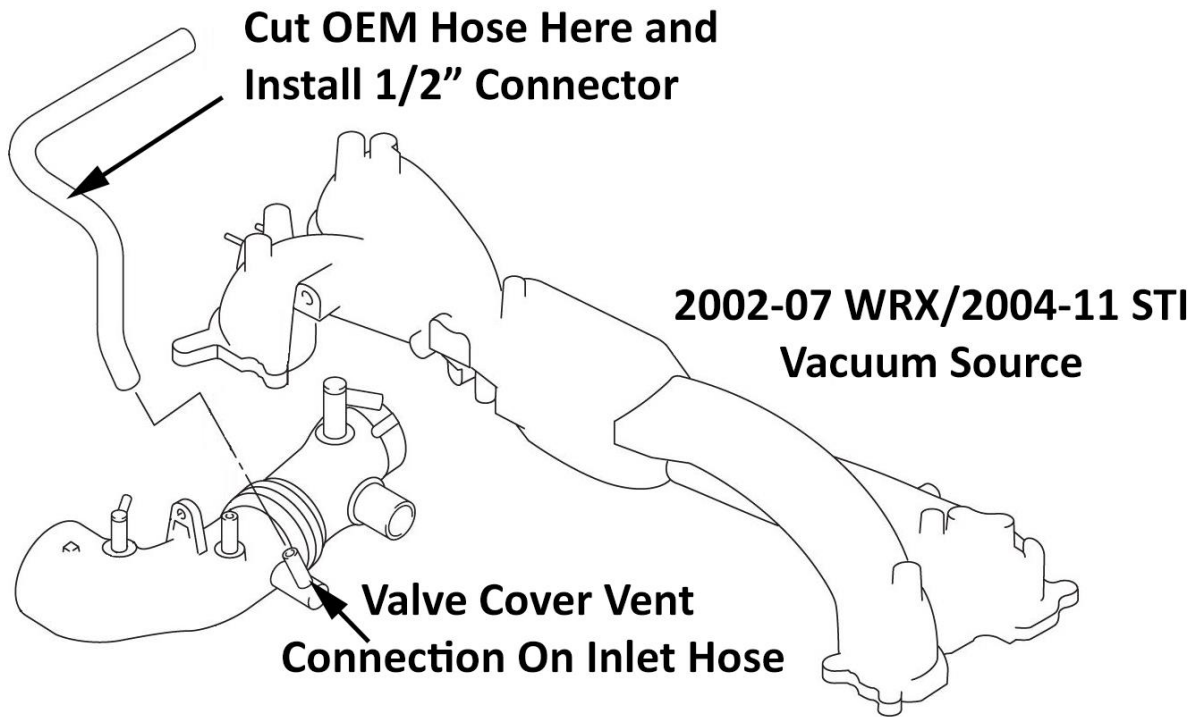

- ii. Vehicles with aftermarket turbo inlet hose will use one of the above installation methods depending on what is supplied with the inlet hose. If installing with PERRIN inlet hose, no additional fittings are needed.



Above picture shows intake vacuum source at turbo inlet hose on 2012+ STI engine with extra PCV diagnosis connector.

- g. Decide where to install PCV valve (one way valve) and "Y" connector along 1/2" emissions hose coming from AOS outlet. **NOTE: The location of this is not important as long as it's along the hose between the AOS top and the turbo intake system. Below are a couple diagrams with different options as to where to make this junction.**

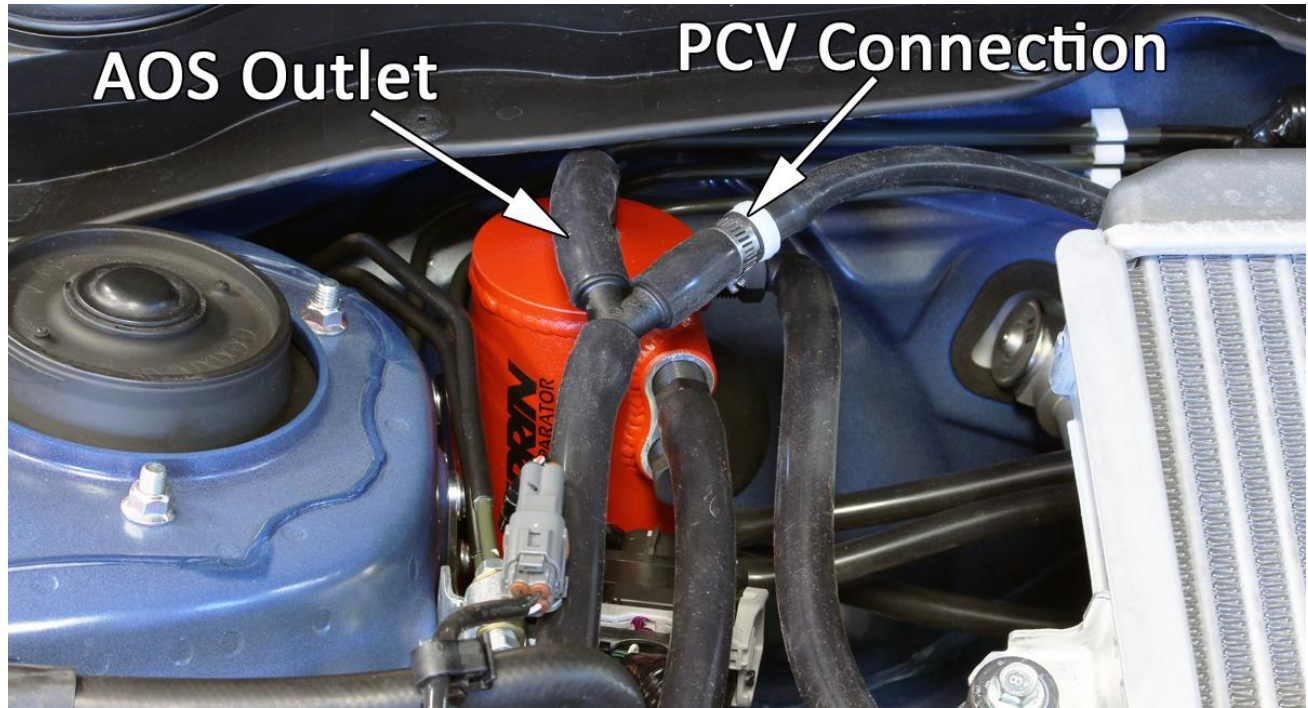

Picture shows Y junction installed at AOS, and PCV location. PCV location does not need to be this close to AOS.

- h. Once desired location is found, cut 1/2" emissions hose and install supplied "Y" connector making sure to aim 3rd leg back toward AOS away from Turbo Intake Vacuum source. Use above and below diagrams to give you a better idea how this can be setup. It is not critical as to the location of PCV valve itself. It can be located close to intake manifold or right at AOS outlet and it will not affect how system works.

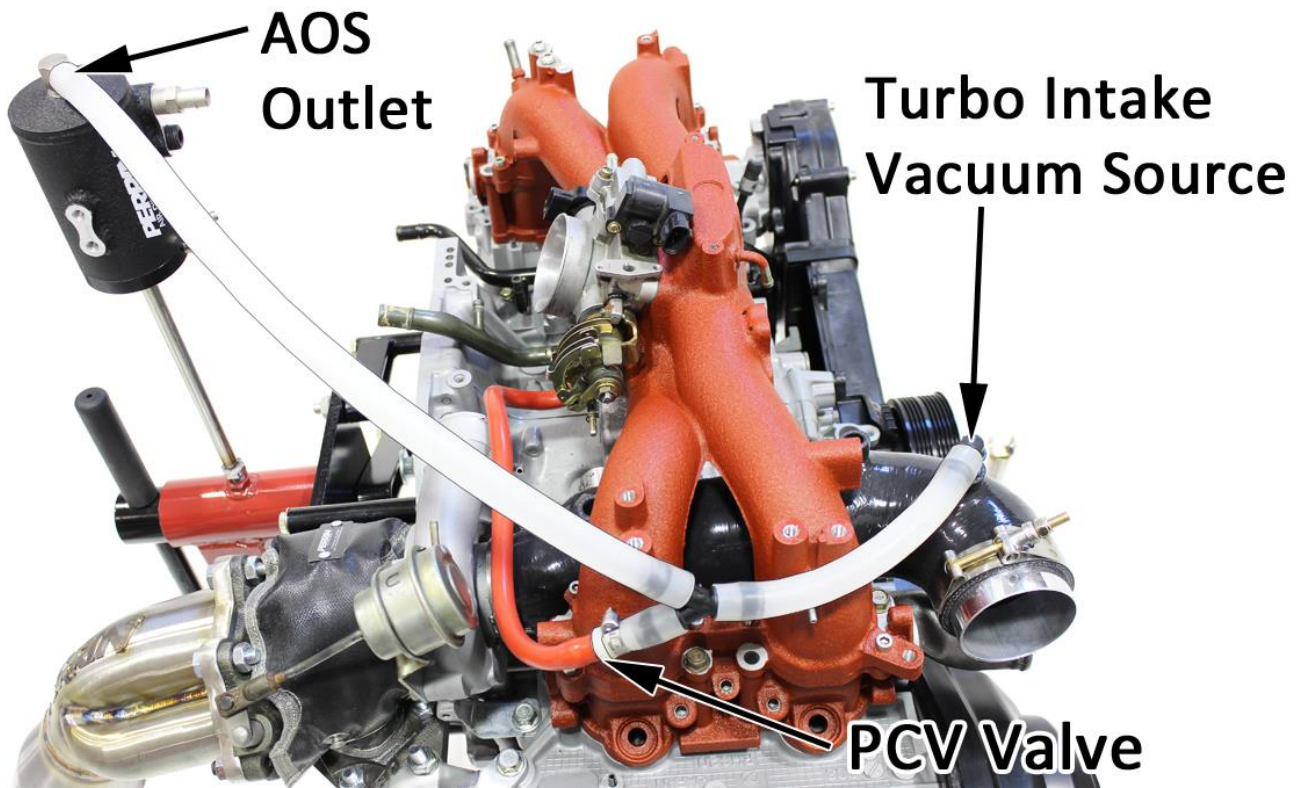

Above diagram shows 04-07 WRX and 04-13 STI setup. 02-03 WRX will NOT have PCV valve located at shown.

- i. For 2002-03 WRX's, connect 1/2" emissions hose coming off PCV valve (threaded into manifold below throttle body) to 3rd leg of "Y" connector. Skip to Step 9 to continue installation.
- j. For all other models, cut a piece of 1/2" emissions hose (2" is what is shown in pictures) and install over 3rd leg of "Y" connector as shown in above and below diagrams. Install 1/2" side of PCV valve assembly (assembled earlier in step 8) into 1/2" emissions hose. Install supplied clamp

and tighten down on hose.

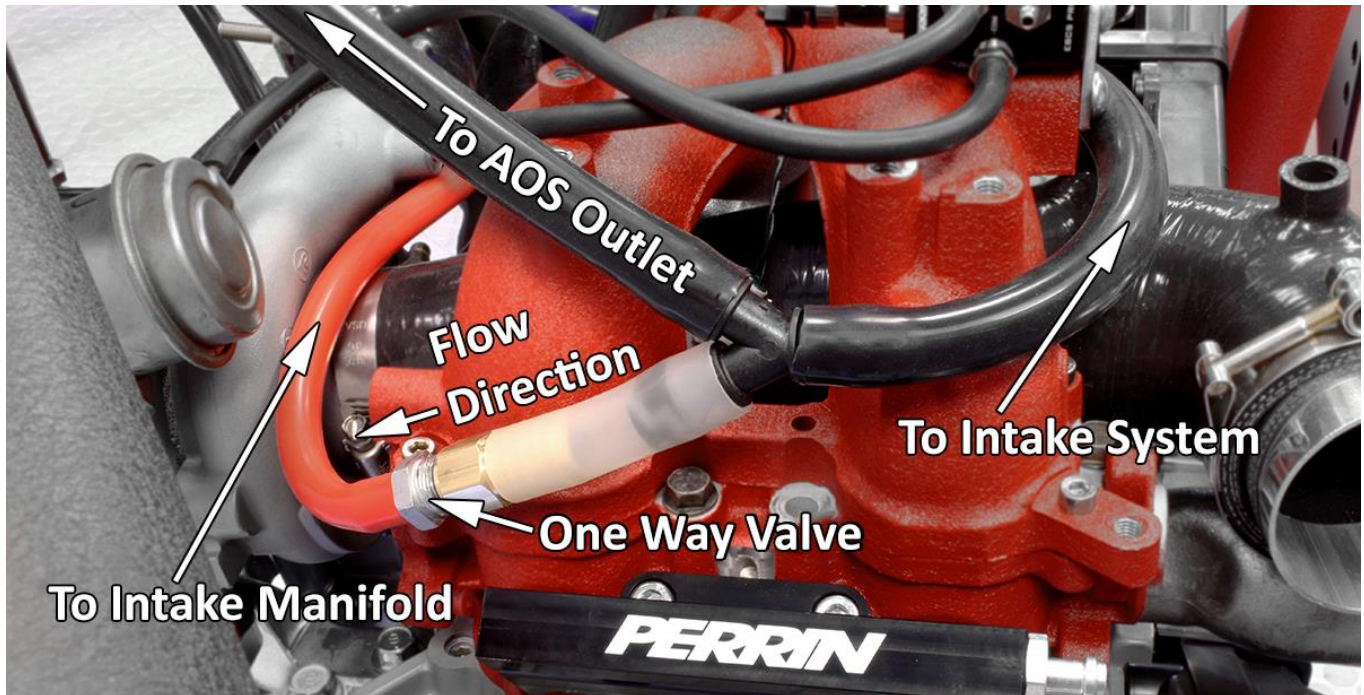

- k. Route previously installed 3/8" fuel hose from intake manifold PCV fitting to 3/8" fitting on PCV valve. Cut hose to length and secure hose with supplied clamps. Using above diagram, ensure that PCV valve (one-way valve) is installed in the correct direction and on the correct leg of "Y" connector.
9. After AOS is completely installed, double check that all hoses and vacuum lines are connected and secured using a clamp. Any leak in the system can cause the engine to run poorly and will lead to unsafe engine conditions.
10. Check that all bolts and hardware securing AOS are tightened down.
11. Reconnect throttle body to intake manifold. **NOTE: Gasket can be reused if it was not damaged during installation.**
12. Using supplied zip ties, secure wire harness (removed in earlier step) toward shock tower or frame rail. **NOTE: Keep away from turbo charger to ensure no damage from heat occurs.**
13. Using supplied zip ties, secure emissions hoses to engine and other hoses to reduce the chance of abrasion wearing down hoses over time.
14. Reinstall intercooler pipes removed earlier and start car. Ensure its running as it was before. Turn off engine and add any coolant that was lost during installation. Restart engine and take car for test drive. If car is misfiring or check engine light occurs, recheck all aspects of install.
15. After roughly 10 minutes of driving, recheck all fittings for signs of leaking. If leaks are found stop and fix ASAP.

PCV Delete for Cars with Built Engines or Increased Amount of Blow-by

While we do not recommend this for street driven cars, some racecars may want to disconnect the PCV side of the system as this can lead to some oil vapors getting into the intake manifold. For those who understand these risks and understand the reason for removing the PCV connection, please follow the below alternate instructions.

- Locate port on intake manifold that PCV was hooked up to. Remove fitting and install supplied 1/4NPT plug into manifold. **NOTE: This is a tapered type of fitting and seals when tight, not when bottomed out. Take care in not over tightening fitting as this can damage intake manifold. See NPT Notes above regarding installation of this fitting.**

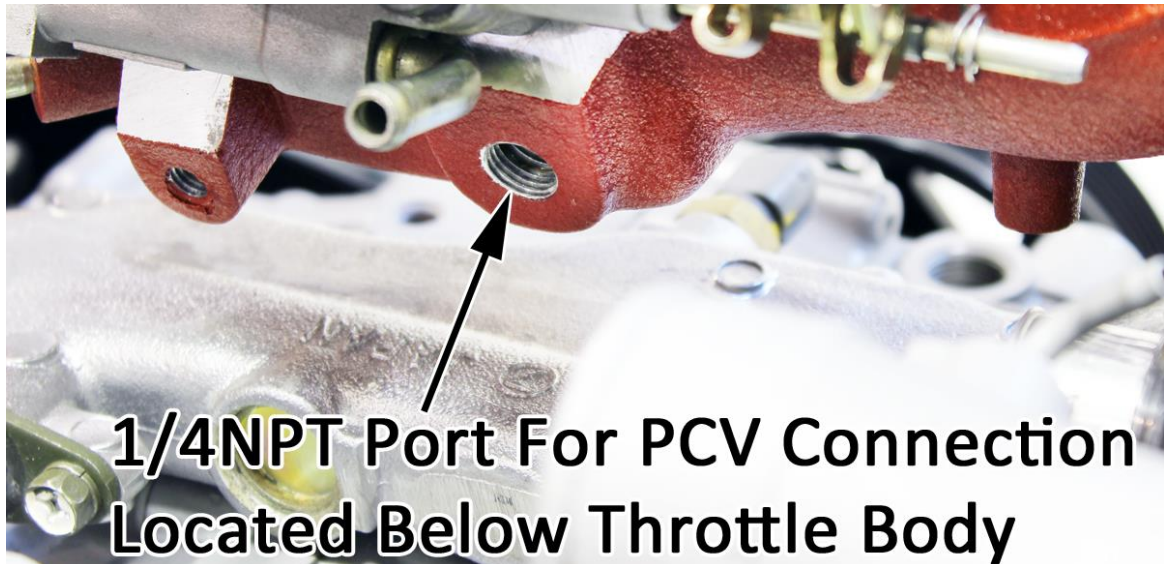

- Using supplied 1/2" emissions hose, connect AOS outlet to intake system somewhere before turbo and after air filter.
- Secure hoses with supplied hose clamps.

Maintaining your Air Oil Separator

- There is very little maintenance required with the PERRIN AOS. From time to time you may want to remove it and clean out some of the oil residue from the inside. Before taking apart, double check you have the spare o-ring in case you find the o-ring is damaged.
- Leaving coolant hoses and oil drain hoses attached to bottom, remove bolt in bottom of AOS using an M5 wrench and remove AOS Body from car. Take note of nylon washer under head of bolt or located in AOS bottom. If this is damaged or missing, please call tech support and order another one.
- If foam filter/diffuser was installed, remove and use a biodegradable degreaser, liberally spray and let it sit for a few minutes. Wash out with warm water until it rinses clean water and is free of oil. Do NOT use brake cleaner on this part as it will destroy the foam.
- Using a biodegradable degreaser, liberally spray inside can and let it sit for a few minutes. Wash out with warm water until inside of AOS is clean and free of oil.

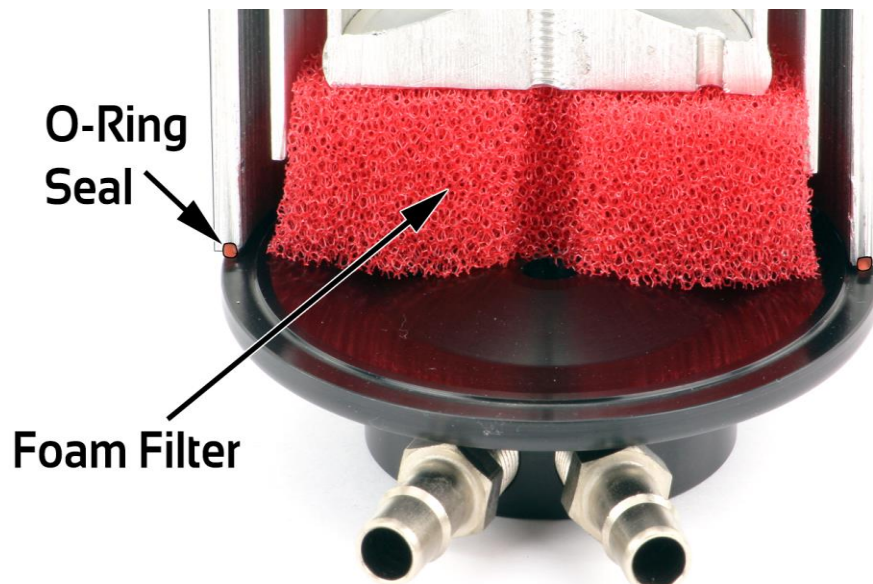

Cutaway Showing Internals of AOS

- Remove and inspect o-ring thoroughly and even remove from bottom to ensure it is not cut or cracked. **Note: Do NOT use brake cleaner to clean O-ring as damage may occur.**
- Install O-ring into groove on into AOS body, making sure it is fully seated in groove and not sticking out.
- Reinstall foam filter/diffuser into AOS body. **NOTE: Remember this is not recommended in climates that drop below freezing.**
- Reinstalled AOS body to bottom, making sure to secure with bolt and nylon washer under head of bolt. Hand tighten bolt, making sure that bottom is

lined up with body and o-ring is not sticking past it.

Crank Case Vent Hook Up for Race Cars/Cars with Loosely Built Engines

We have found that to help control oil entering the AOS you can alternatively remove the crank case vent hose from the system, leaving only valve cover vents to do the job of venting crank case pressures. Consult your tuner to decide if this is the best setup for your car.

- Remove fitting on AOS body used for crank case vent and install supplied 3/8NPT plug.
- Remove 1/2" fitting on PERRIN crank case vent junction and install supplied 1/4NPT plug.
- This turns the PERRIN crank case vent junction into a drain-only for your AOS.



Questions, Comments and Suggestions Contact: Tech@PERRINperformance.com

Visit Our Website for Instant Chat Options at www.PERRINperformance.com

Call Our Tech Team at 503-693-1702