



DINAN

ADJUSTABLE ANTI-ROLL BAR INSTALLATION INSTRUCTIONS

PART NUMBER D120-0580

DESCRIPTION: Front 28mm; 3-hole adjustable

APPLICATION: 2014-16 F22 228i/M235i

2013-16 F30 320i

2012-16 F30 328i

2012-15 F30 335i

2016 F30 LCI 340i

2014-16 F32 428i/435i

2014-16 F33 428i/435i Convertible

2015-16 F36 428i/435i Gran Coupe

PARTS LIST

Qty	Part #	Description
1	D122-0580	Anti-roll bar
1	D133-0580	Hardware kit

Congratulations for being selective enough to use a Dinan anti-roll bar. We have spent many hours developing this anti-roll bar to assure that you will receive maximum performance and durability with minimum difficulty in installation. Please take the time to read these instructions and call us if you have any difficulties during the installation.

NOTES:

- The steps in this instruction set are intended as an overview of the factory procedure. A few shortcuts have been provided to expedite the procedure.
 - A thorough understanding of the factory procedure & torque specs to remove and replace the front swaybar is required. **Do not attempt this installation without the factory procedure available to you.**
 - We highly recommend that you first read and fully understand these instructions before beginning the installation.
 - Some mechanical skill is required to install this kit. If you feel that you do not have the requisite skill or tools, please arrange for a qualified repair facility to perform the installation.
 - Do not work on vehicles supported by a jack only. Use secure jack stands!
-

1. **This front swaybar is not applicable for any xDrive vehicles!**
2. Disconnect the ground from the battery.
3. Jack up the front of the vehicle and place jack stands securely under the vehicle.
4. Remove front wheels and set aside.
5. Remove the underside cover and both fender liners.
6. Install the underhood engine support per BMW procedure.
7. If present, remove the three clips for the coolant pipe so it can move around freely.



- Remove the 4 clips that secure the wiring harness for the steering rack.

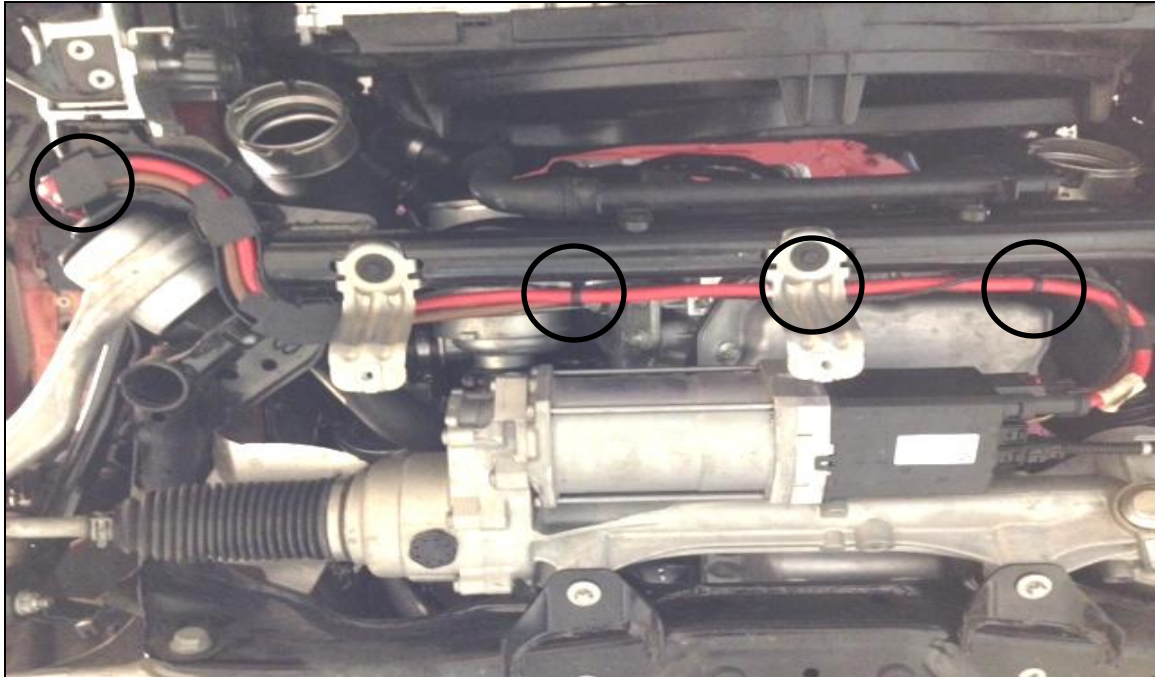

- Disconnect the two plugs of the rack and move it out of the way.



10. Lock down the steering wheel so it cannot move. **This is vital! If the steering wheel spins around, it will cause damage!**
11. Remove the bolt for the steering shaft on the rack side.



12. Remove the 3 bolts from both sides of the motor mount.



13. Disconnect endlinks from swaybar. Leave endlinks attached to strut.

14. Separate the ride height sensor from the lower control arm and unplug sensor.



15. Remove the two bolts on both sides of the subframe going to the front bumper, then remove the wire holder from the frame.

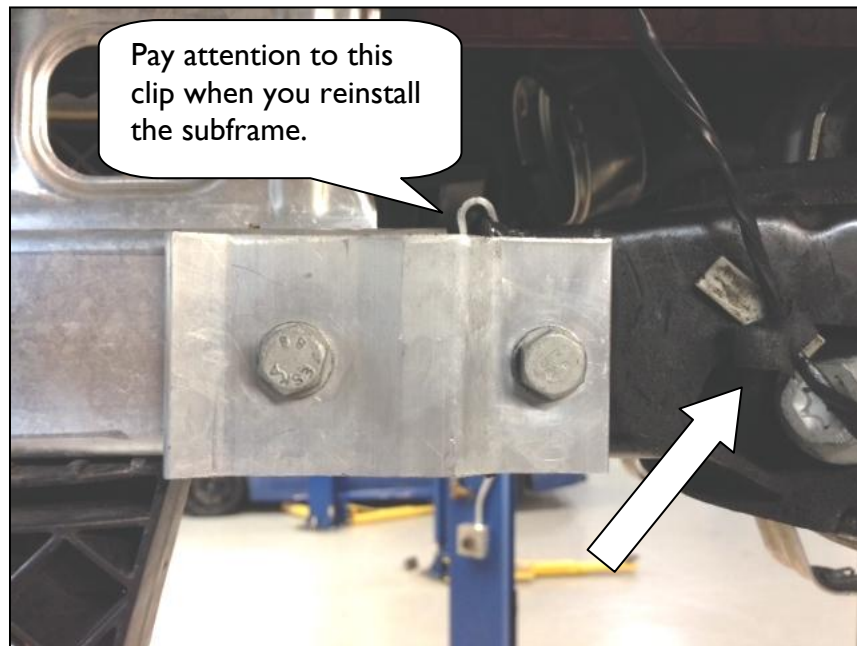

16. Loosen the two subframe rear bolts. **Only loosen these bolts two or three turns at the most!**

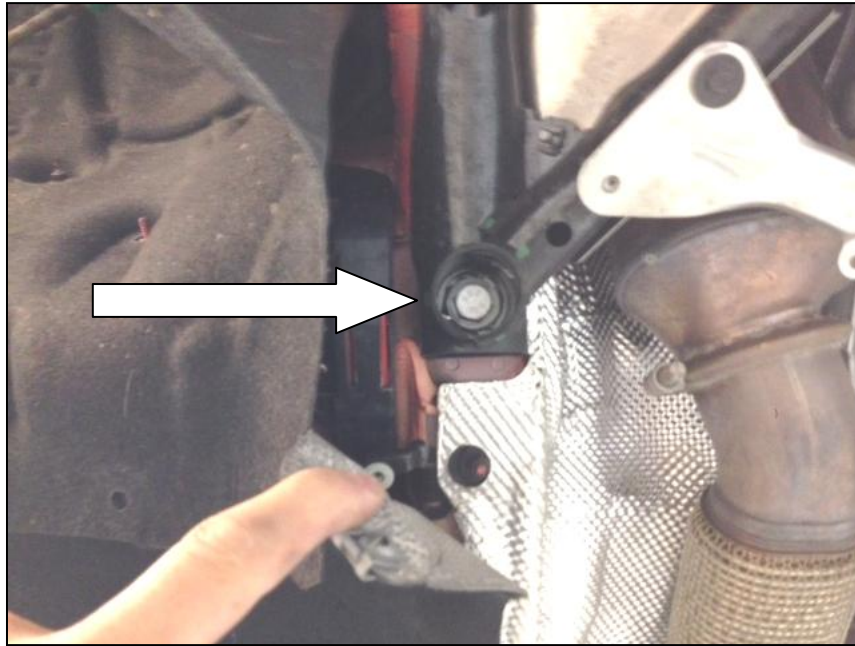

17. Use a pole or floor jack to support the front of the subframe.



18. Remove the 4 bolts for the front of the subframe.

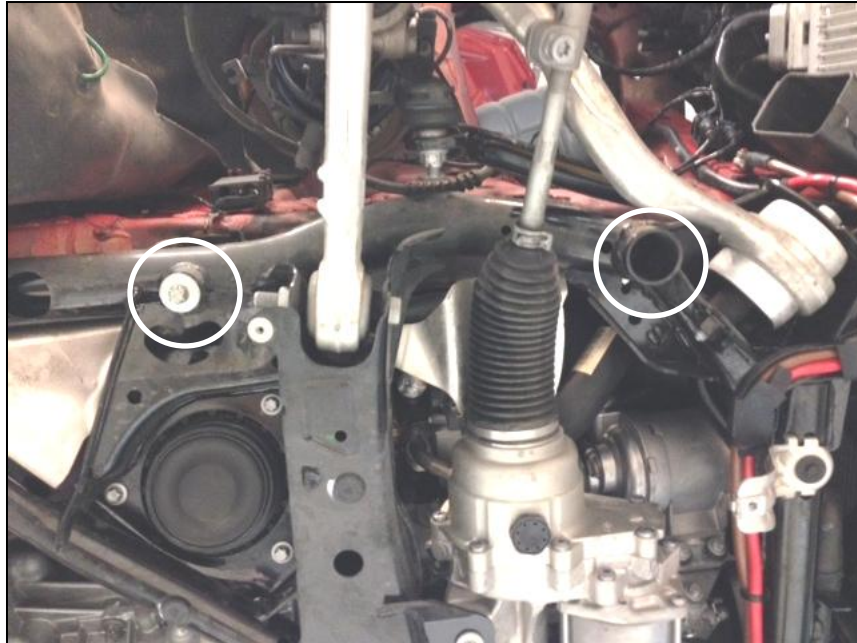

19. Lower the subframe down about 4" to 6". You may need to slightly pry the subframe to accomplish this.

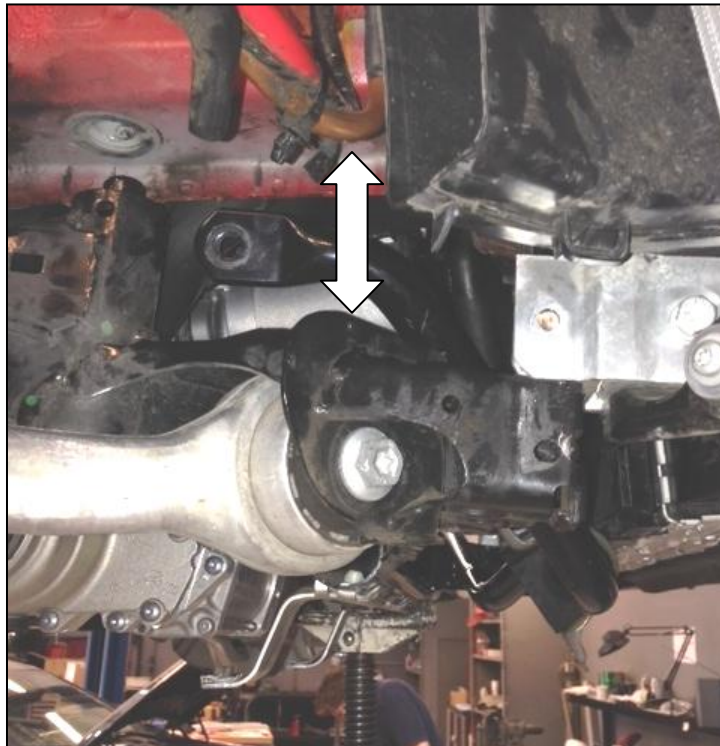

20. Remove the four nuts securing the swaybar brackets.
21. Remove front swaybar from vehicle.
 - On the left side strut, separate the brake line and any wires from their holders on the strut tube, and leave them loose so they can be moved aside later. There is no need to disconnect any of the lines.
 - While moving the bar to the left, rotate the bar to get the large bend into the position shown. If necessary, lower the subframe further.



- Move the bar further to the left and rotate as needed to remove the bar from the bottom.

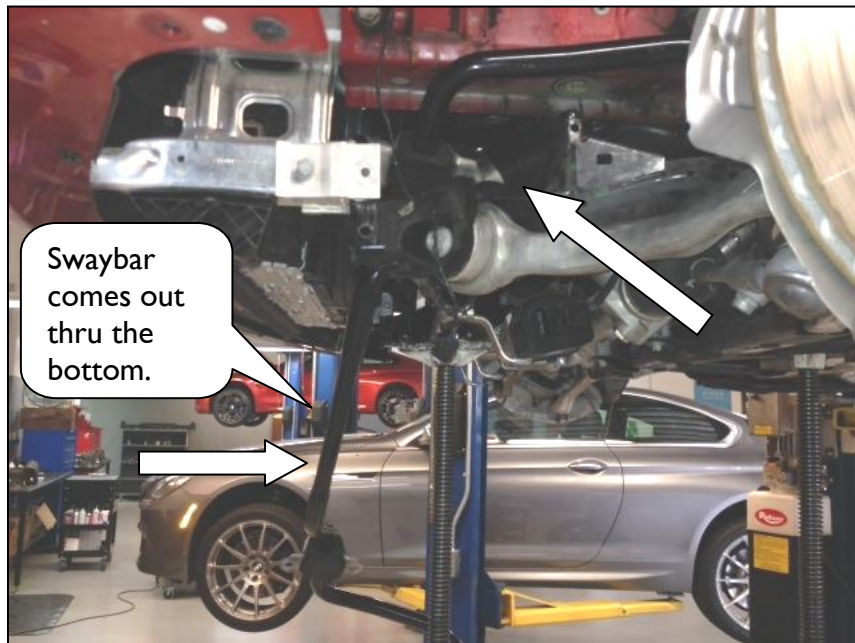

STEPS 23 THRU 27 ARE FOR N20 & N26 4-cyl VEHICLES ONLY

22. To obtain adequate clearance, the coolant hose above the front subframe tube must be relocated downward. The hose can remain connected during this procedure.
23. Unclip the hose from its holders.

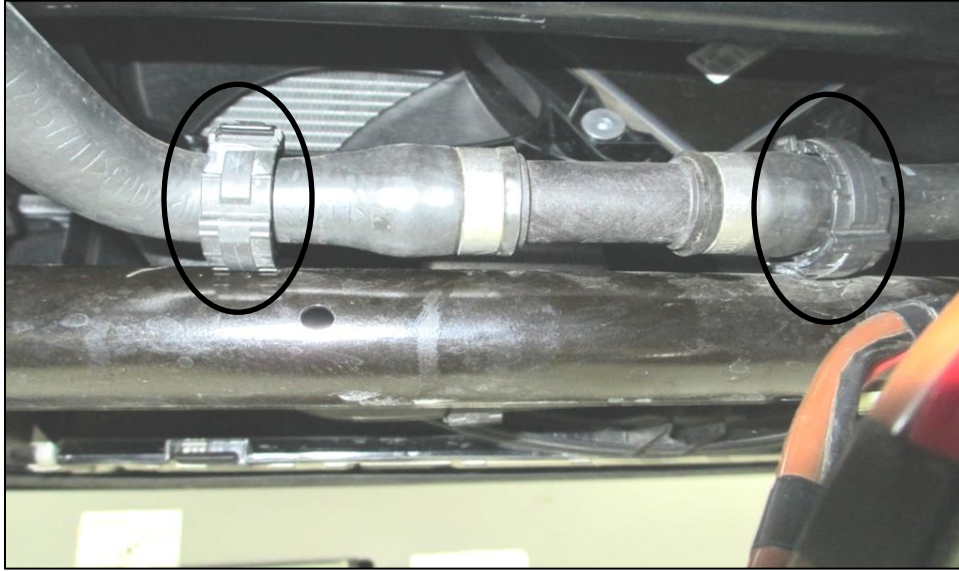

24. Then remove the holders from the subframe by pulling up on the tab to unlock it (see arrow). One of these holders will be reused. The other will be discarded.

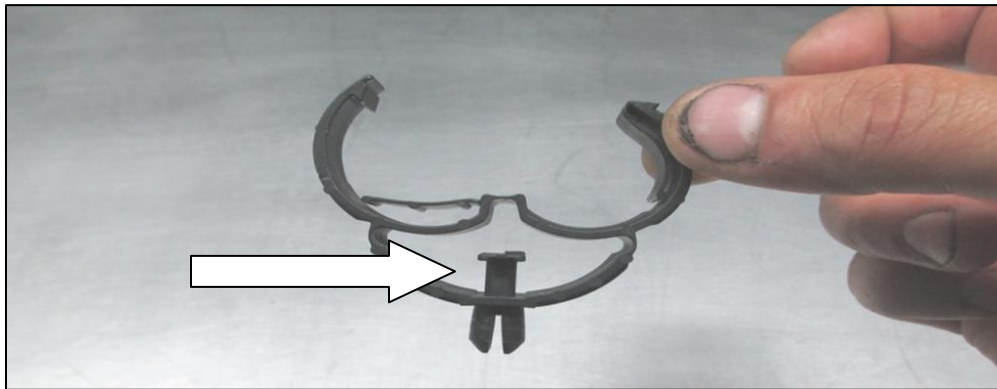

25. Using the included 1 1/32" drill bit and angled drill, drill out the existing hole at the left side of the subframe.

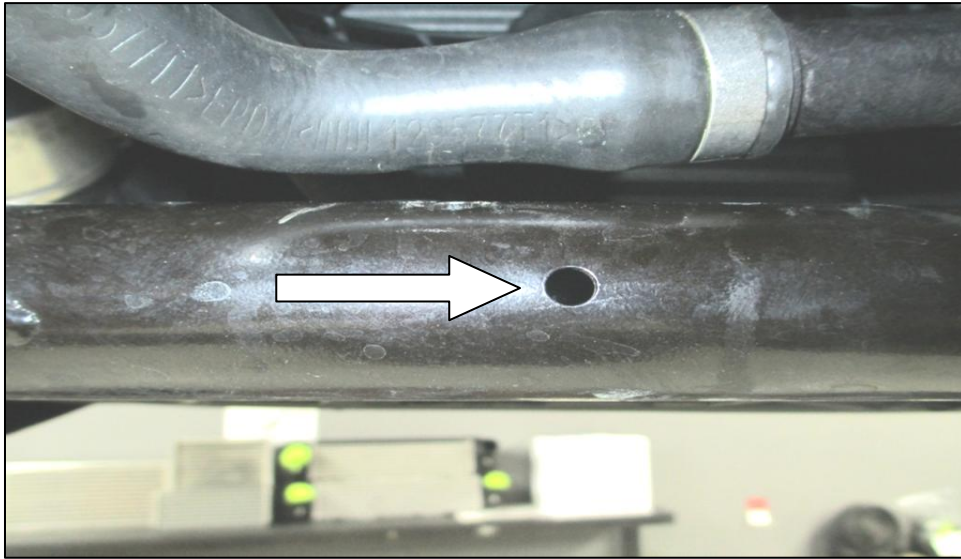

26. Install one of the holders into this hole, and clip the hose into its new location. One holder is adequate to hold this hose.

27. Install the Dinan swaybar by reversing the process, and using the supplied bushings and brackets. Lubricate the bushings with the supplied urethane grease (or an equivalent high-pressure, waterproof, grease).
28. See figure below for description of adjustments, and determine which hole you will be using. Dinan recommends starting at the indicated setting, and then adjusting as needed after evaluating the handling.

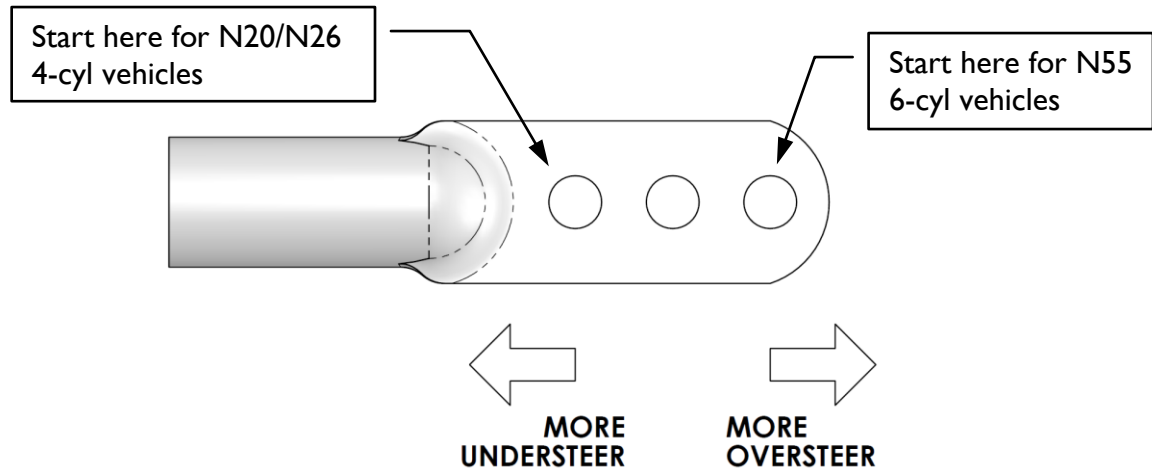

We hope you enjoy your new Dinan anti-roll bar!



DINAN

ADJUSTABLE ANTI-ROLL BAR INSTALLATION INSTRUCTIONS

PART NUMBER D120-0590

DESCRIPTION: Rear 19mm; 3-hole adjustable

APPLICATION: 2014-16 F22 228i/M235i

2013-16 F30 320i

2012-16 F30 328i

2012-15 F30 335i

2016 F30 LCI 340i

2014-16 F32 428i/435i

2014-16 F33 428i/435i Convertible

2015-16 F36 428i/435i Gran Coupe

PARTS LIST

Qty	Part #	Description
1	D122-0590	Anti-roll bar
1	D133-0590	Hardware kit

Congratulations for being selective enough to use a Dinan anti-roll bar. We have spent many hours developing this anti-roll bar to assure that you will receive maximum performance and durability with minimum difficulty in installation. Please take the time to read these instructions and call us if you have any difficulties during the installation.

NOTES:

- The steps in this instruction set are intended as an overview of the factory procedure. A few shortcuts have been provided to expedite the procedure.
 - A thorough understanding of the factory procedure & torque specs to remove and replace the rear swaybar is required. **Do not attempt this installation without the factory procedure available to you.**
 - We highly recommend that you first read and fully understand these instructions before beginning the installation.
 - Some mechanical skill is required to install this kit. If you feel that you do not have the requisite skill or tools, please arrange for a qualified repair facility to perform the installation.
 - Do not work on vehicles supported by a jack only. Use secure jack stands!
-

1. Jack up the rear of the vehicle and place jack stands securely under the vehicle. Remove both rear wheels.
2. Remove the 6 bolts from the center reinforcement plate as shown. Remove plate and set aside.

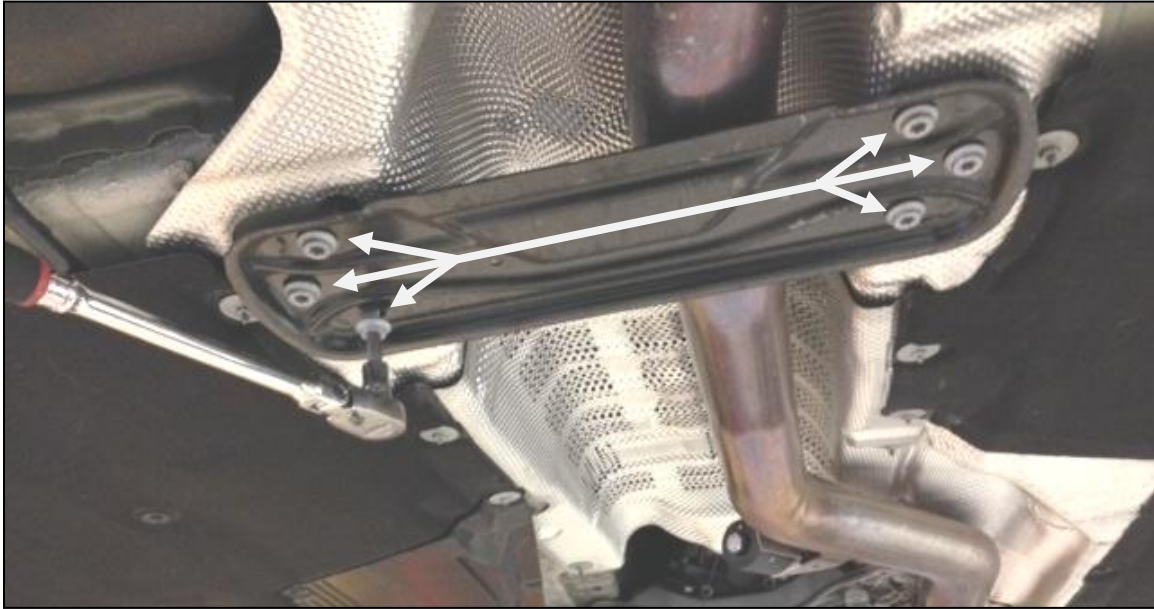

3. Remove the 4 nuts from both lower control arm covers. Remove covers and set aside.



4. Remove exhaust system:
 - Using a pole jack or floor jack, support muffler as shown by the large arrow.
 - Remove the two nuts for the exhaust hangers (shown by the small arrows).
 - If applicable, disconnect the exhaust valve.
 - Loosen the front clamp at the catalyst outlet, and remove the two bolts for the mount at the cross member.
 - Remove the exhaust in its entirety.

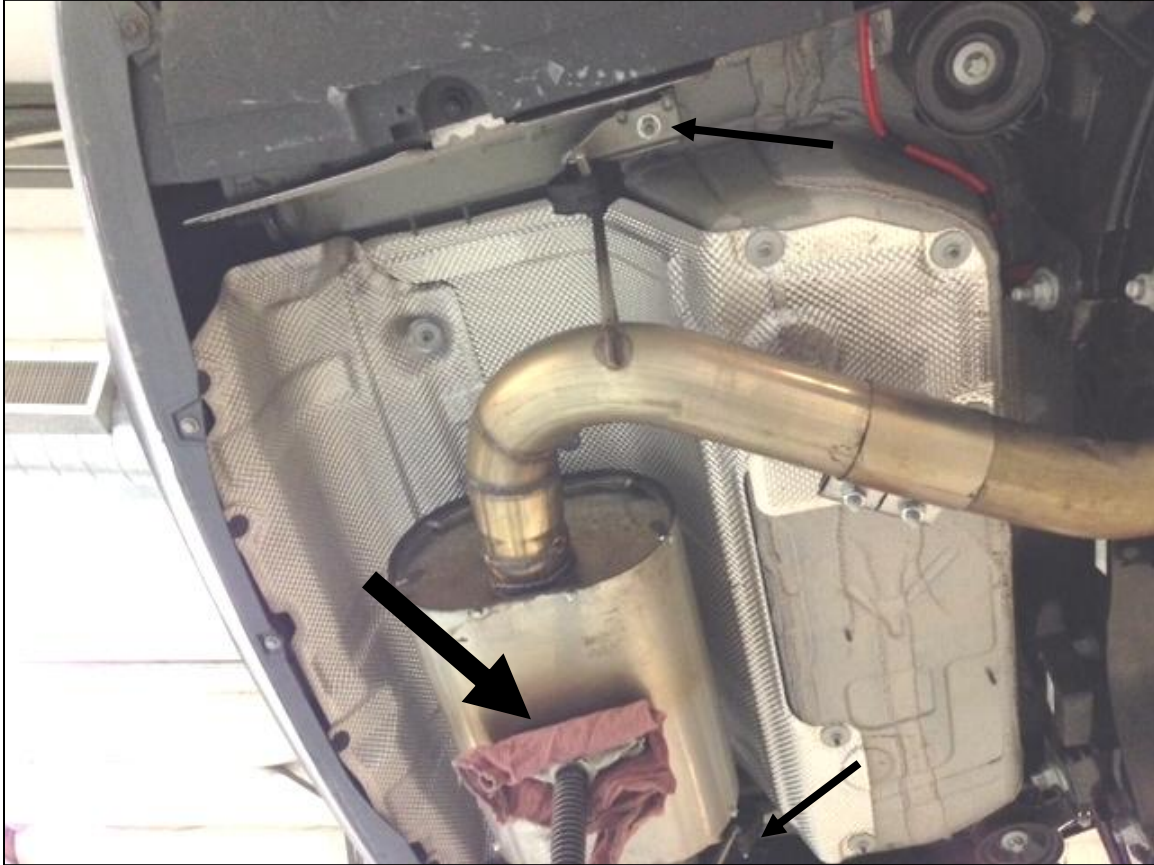

5. Remove center heat shield.

- The rear shield is under the front shield, and can be removed without removing the other shields.
- Remove the 8 nuts for the center heat shield as shown.
- Pull down the heat shield at the arrows to separate the front shield.

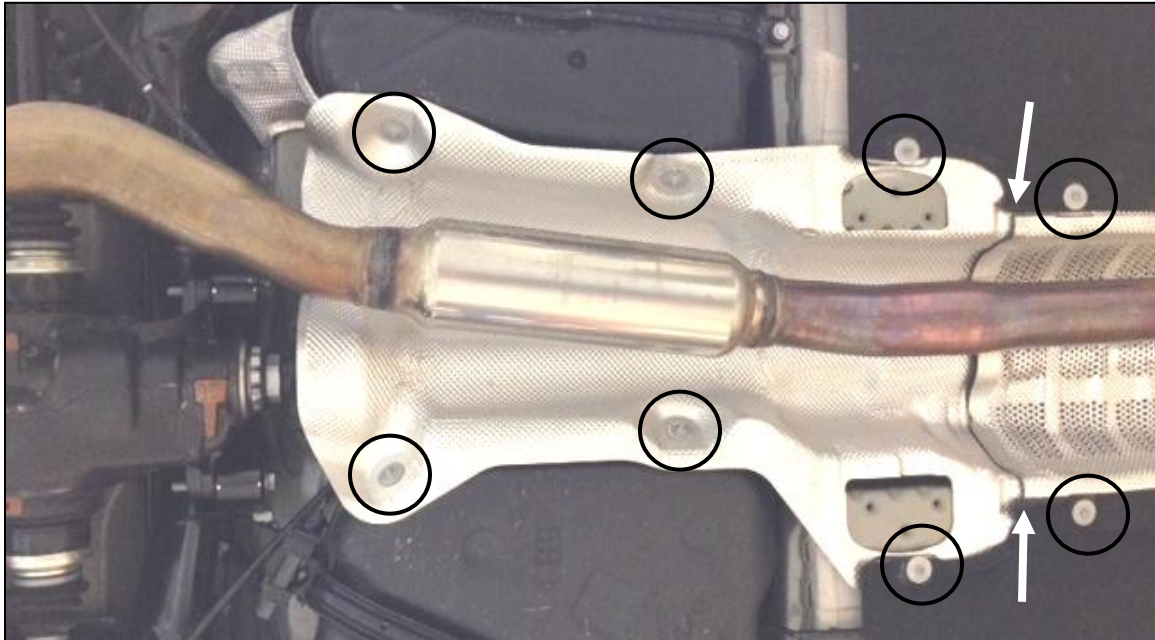

- Pull down and remove the shield off of the studs. Take care to avoid bending the shield.

6. With the heat shield out of the car, remove the two bolts for the center support bearing.



7. Disconnect both swaybar endlinks from the bar and move them out of the way.
8. Remove the plastic covers from both sides of the vehicle. Each cover is attached with 6 plastic pins and one bolt as shown.



9. Use pole or floor jack to support the front of the differential housing as shown.

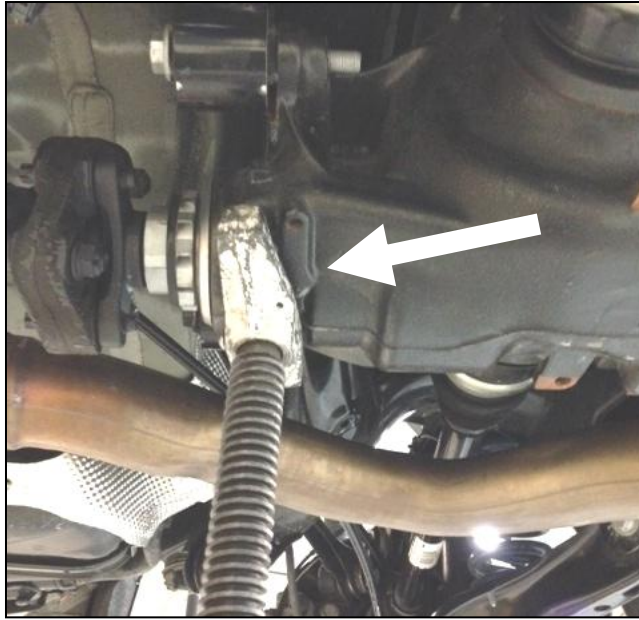

10. Remove the front bolts & brackets as shown at the front of the subframe .



11. Lower the pole/floor jack about 3".



12. Remove the bolts for the swaybar mounts.

13. The swaybar is now loose. Move the swaybar to the top side of the upper control arms of both sides as shown.



- Snake the bar out of the car as shown.



- Carefully snake the Dinan bar into place.
- Lubricate the Dinan bushings with the supplied urethane grease (or an equivalent high-pressure, waterproof, grease). Install bushings on swaybar near the bends.
- Install the supplied brackets using the included fender washers under the stock attachment bolts as shown.

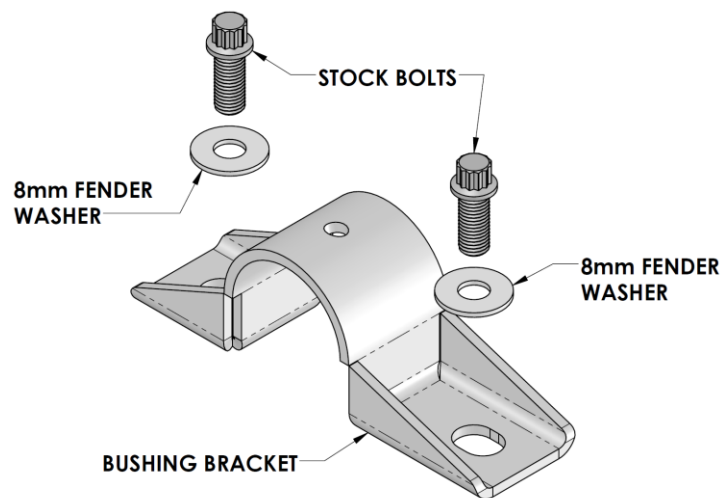

- Reverse the steps and reassemble the car. Be sure to torque all fasteners to BMW recommended specifications.

19. See figure below for description of adjustments, and determine which hole you will be using. Dinan recommends starting at the indicated setting, and then adjusting as needed after evaluating the handling.

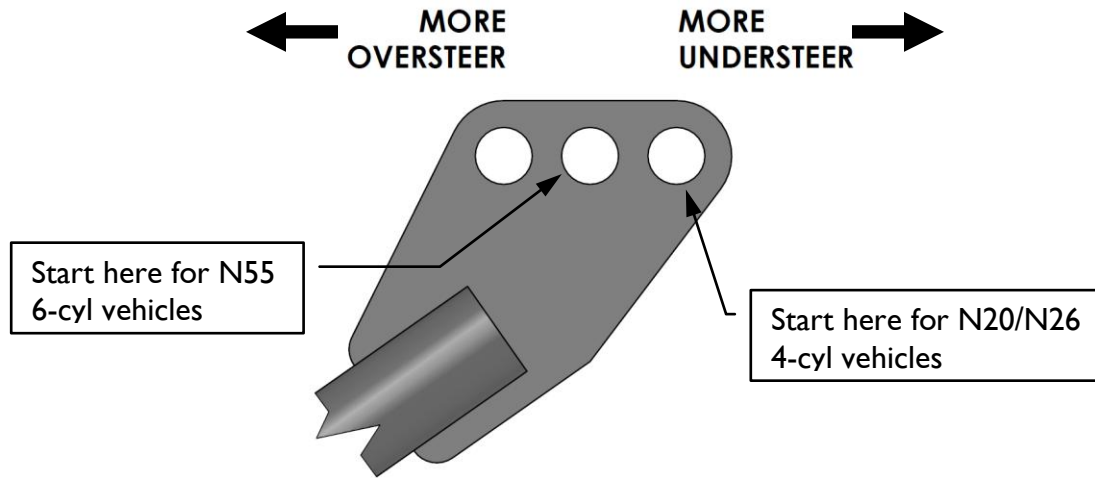

We hope you enjoy your new Dinan anti-roll bar!