

# Installation Instructions

I - Sheet Number BF07 Rev.C



## Bugflector® - Bugflector II® - Carflector® - Chrome Hood Shield™

For proper installation and best possible fit, please read all instructions BEFORE you begin.  
For technical assistance or to obtain missing parts, please call Customer Relations at 1-800-241-7219.

### Important Safety Information



- CAUTION - Before driving, ensure that the hood shield is properly anchored to vehicle.
- Do not use automatic "brush-style" car washes.
- Do not use cleaning solvents of any kind.
- Periodically check all components for tightness.

### Contents **NOTE:** Actual product may vary from illustration.



Hood Shield



Bump On x4



Alcohol Pad x2

### Tools Required



Car Wash Supplies



Clean Towel

### Preparation Before Painting / Installation

- A trial fit is recommended to ensure proper positioning and fit.
- Check fit of parts before painting as we will not accept the return of modified or painted parts.
- Wash your vehicle's hood to remove any debris and/or dirt.
- Dry the hood with a clean towel.

### Installation Steps **NOTE:** Actual application may vary slightly from illustrations.



Clean mounting surface with alcohol pad.

Peel back 2" of tape liner from back of hood shield at each end of bottom flange.

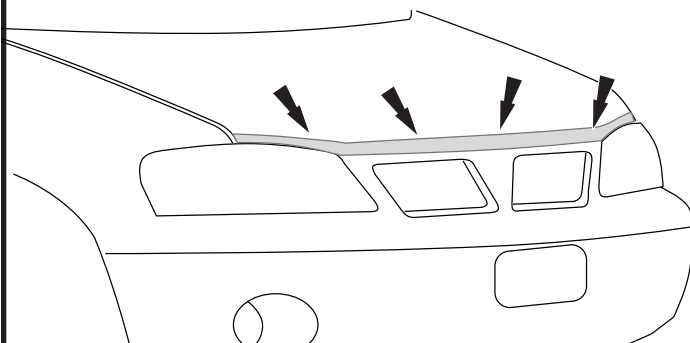

1

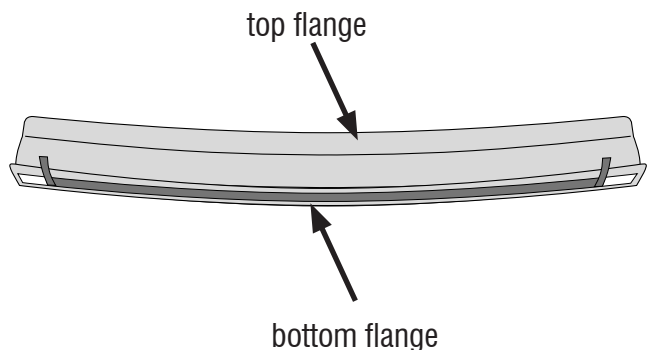

2

## Installation Steps **NOTE:** Actual application may vary slightly from illustrations.

Align Hood Shield center point with center of hood.

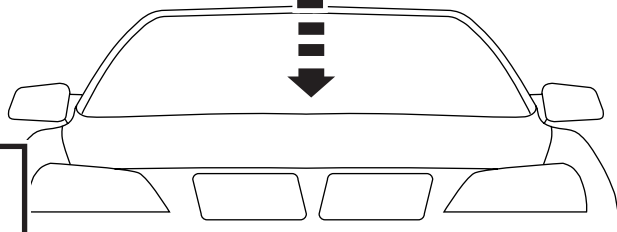

3

Press on exposed tape to adhere to hood. Remove remainder of tape lining by pulling on the free ends.

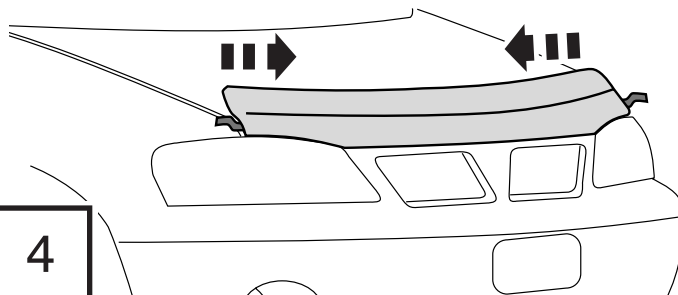

4



Press firmly along tape flange to secure hood shield to vehicle hood.

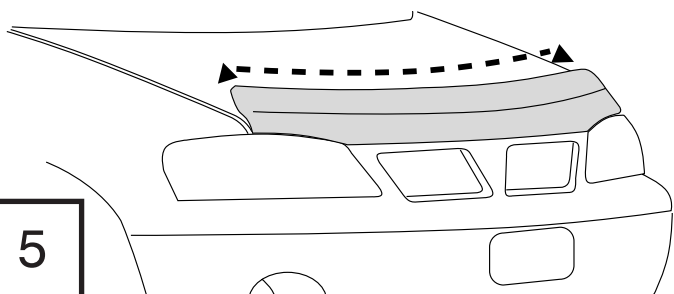

5



Apply bump ons to surface of hood.

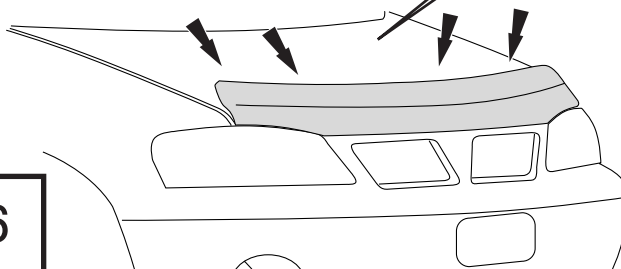
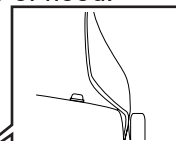

6

## Care and Cleaning

- Wash only with mild soap & dry with a clean cloth.

## Congratulations!

You have purchased one of the many quality Auto Ventshade™ branded products offered by Lund International, Inc. We take the utmost pride in our products and want you to enjoy years of satisfaction from your investment. We have made every effort to ensure that your product is top quality in terms of fit, durability, finish and ease of installation.



Lund International

800-241-7219 • Visit us at [lundinternational.com](http://lundinternational.com)

© 2012 Lund International, Inc. All rights reserved.

Auto Ventshade™, the Auto Ventshade™ logo and the AVS™ logo are trademarks of Lund International, Inc.



# Instructions d'installation

I- Feuille numéro BF07 Rév.C



**Bugflector® - Bugflector II® - Carflector® - Chrome Hood Shield™**

Pour obtenir une installation correcte et le meilleur ajustement possible, lire toutes les instructions AVANT de commencer.  
Pour toute assistance technique ou obtention de pièces manquantes, appeler le service des relations avec la clientèle au 1-800-241-7219.

## Informations importantes concernant la sécurité



- ATTENTION – Avant de conduire, s'assurer que le pare-insectes est solidement assujettie sur le véhicule.
- Ne pas utiliser les stations de lavage de voitures à brosses.
- Ne pas utiliser de solvants.
- Vérifier régulièrement le serrage des composants.

## Contenu

**NOTE:** Le produit réel peut changer de l'illustration.



Pare-insectes

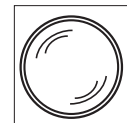

Butoirs (4)



Tampons à l'alcool (2)

## Outils nécessaires



Fournitures pour lavage de voiture



Serviette propre

## Préparation pour la peinture/l'installation

- Il est recommandé de procéder à un essai pour s'assurer que le positionnement et l'ajustement sont corrects.
- Vérifier l'ajustement des pièces avant peinture, car nous n'acceptons pas le retour de pièces modifiées ou peintes.
- Laver les glissières de glaces de la portière du véhicule pour éliminer toute poussière et tous débris.
- Sécher les glissières avec une serviette propre.

## Étapes d'installation

**REMARQUE :** La méthode d'application peut être légèrement différente de celle représentée par les illustrations.



Nettoyer la surface de montage à l'aide d'un tampon à l'alcool.

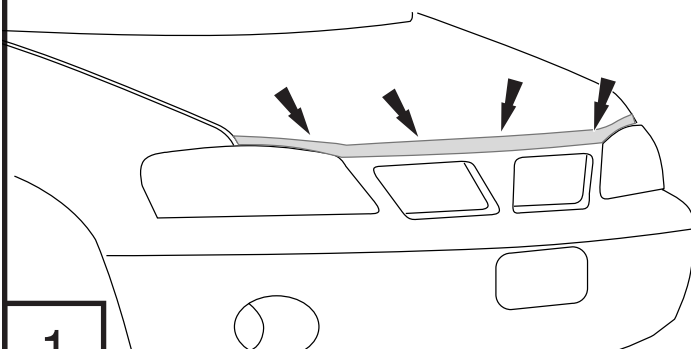

1

Décoller environ 5 cm (2 po) de protection d'adhésif de l'arrière du pare-insectes, à chaque extrémité du rebord inférieur.

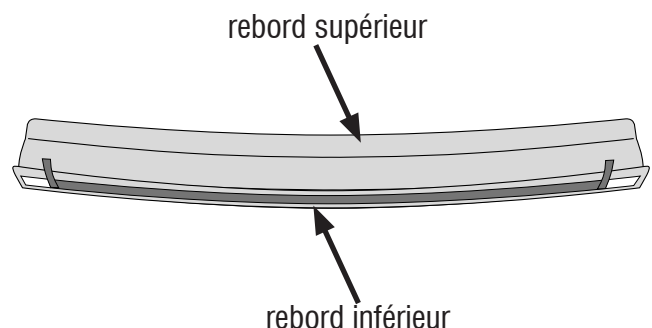

2

## Étapes d'installation

REMARQUE : La méthode d'application peut être légèrement différente de celle représentée par les illustrations.

Aligner le point central du pare-insectes et le centre du capot.

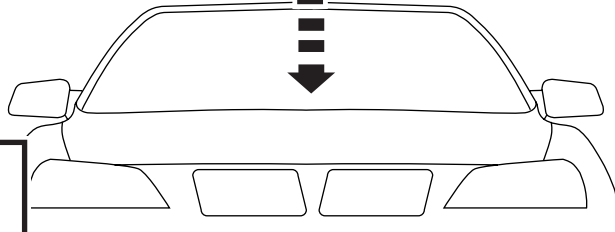

3

Appuyer sur la partie exposée du ruban adhésif pour le faire adhérer au capot. Retirer le reste de la protection d'adhésif en tirant sur les extrémités libres.

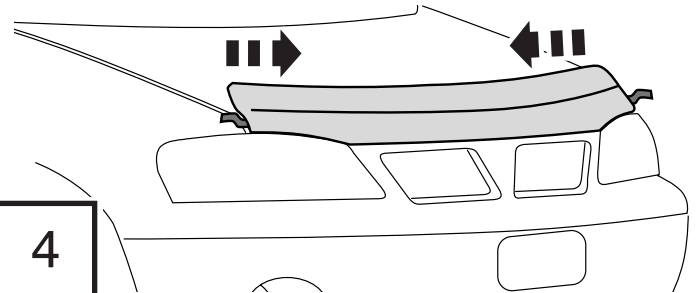

4

Appuyer fermement tout le long du rebord du ruban adhésif pour fixer le pare-insectes sur le capot du véhicule.

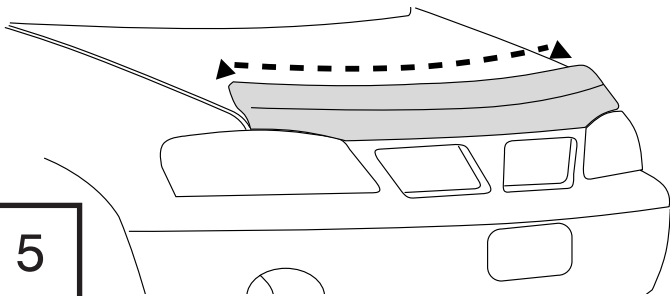

5

Appliquer les butoirs sur le capot.

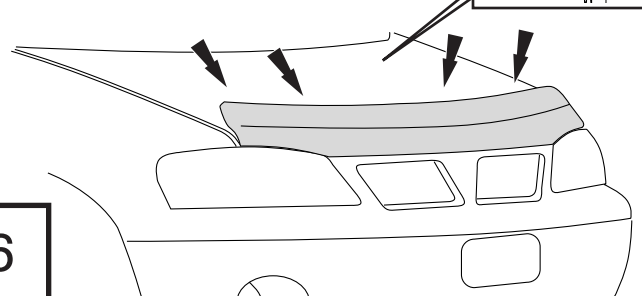
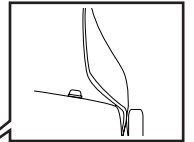

6

## Entretien et nettoyage

- Laver exclusivement avec de l'eau savonneuse et sécher avec un chiffon propre.

## Félicitations !

Vous avez acheté l'un des nombreux produits de qualité Auto Ventshade™ fabriqués par Lund International, Inc. Nous sommes extrêmement fiers de nos produits et souhaitons que vous tiriez des années de satisfaction de votre investissement. Nous avons pris toutes les mesures nécessaires pour assurer que ce produit est d'une qualité supérieure en ce qui concerne l'ajustement, la durabilité, la finition et la facilité d'installation.



Lund International

800-241-7219 • Visitez notre site [lundinternational.com](http://lundinternational.com)

© 2012 Lund International, Inc. Tous droits réservés.



Auto Ventshade™, le logo Auto Ventshade™ et le logo AVS™ sont des marques déposées de Lund International, Inc.





## Bugflector® - Bugflector II® - Carflector® - Chrome Hood Shield™

Para una instalación adecuada y el mejor ajuste posible, lea todas las instrucciones ANTES de comenzar. Si desea recibir asistencia técnica u obtener piezas faltantes, llame al Servicio al cliente al 1-800-241-7219.

### Información importante de seguridad



- PRECAUCIÓN - Antes de conducir, asegúrese de que la Cubierta para capó esté correctamente anclada al vehículo.
- No utilice servicios automáticos de limpieza de vehículos que utilizan cepillos.
- No utilice limpiadores al solvente de ningún tipo.
- Compruebe periódicamente que todos los componentes estén ajustados.

### Contenido

**NOTA:** El producto real puede variar de la ilustración.



Cubierta para capó



Soporte x 4



Paño esterilizado x2

### Herramientas necesarias



Equipo de limpieza de vehículos



Toalla limpia

### Preparación antes de pintar o instalar

- Se recomienda realizar un ajuste de prueba para asegurar el posicionamiento y ajuste correctos.
- Compruebe que las piezas se ajusten correctamente antes de pintarlas, ya que no aceptaremos la devolución de piezas modificadas o pintadas.
- Lave los canales de la ventanilla del vehículo para quitar los desechos y la suciedad.
- Seque los canales de la ventanilla con una toalla limpia.

### Pasos de instalación

**NOTA:** El uso real puede variar levemente de ilustraciones.



Limpie la superficie de colocación con un paño esterilizado.

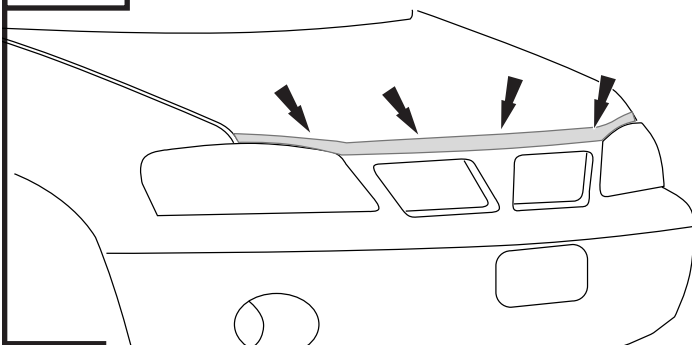

1

Retire 2 pulgs. de cinta protectora de la parte posterior de cubierta para capó en cada uno de los extremos del reborde inferior.

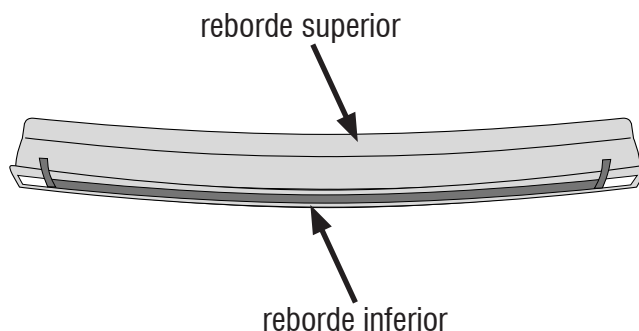

2

**Pasos de instalación** **AVISO:** La colocación real puede variar levemente con respecto a las ilustraciones.

Alinee el centro de la cubierta para capó con el centro del capó.

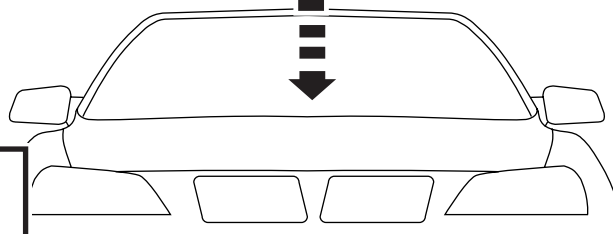

3

Presione sobre la cinta expuesta para fijar al capó. Retire la cinta protectora restante tirando de los extremos libres.

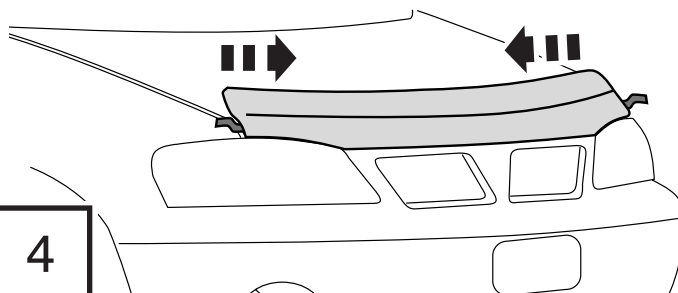

4



Presione firmemente sobre el reborde de la cinta para fijar la cubierta para capó al capó del vehículo.

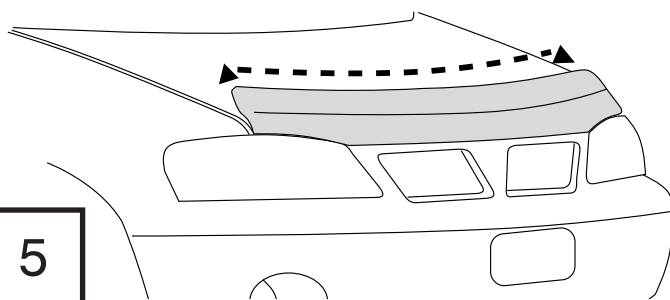

5



Coloque los soportes en la superficie del capó.

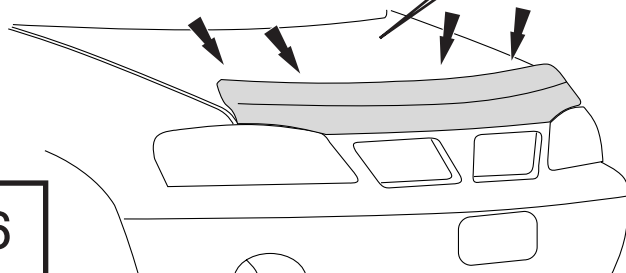
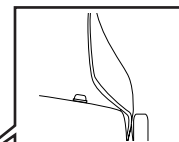

6

## Cuidado y limpieza

- Limpie solamente con agua jabonosa tibia y seque con un paño limpio.

## Felicidades

Usted ha comprado uno de los tantos artículos de calidad de Auto Ventshade™ ofrecidos por Lund International, Inc. Nuestros productos son nuestro mayor orgullo. Deseamos que disfrute de años de satisfacción con su inversión. Hemos realizado todos los esfuerzos para asegurarnos de que su producto sea de la mejor calidad en cuanto a ajuste, durabilidad, acabado y facilidad de instalación.



Lund International

800-241-7219 • Visite nuestro sitio Web: [lundinternational.com](http://lundinternational.com)

© 2012 Lund International, Inc. Todos los derechos reservados.



Auto Ventshade™, el logo de Auto Ventshade™ y el logo de AVS™ son marcas comerciales de Lund International, Inc.

